

ALIRA  
DENTAL

**INSTRUMENTS**



PRODUCT CATALOGUE





## **DISCLAIMER & CONFIDENTIALITY**

This catalog is confidential and for your information only and is not intended as an offer, or a solicitation of an offer, to buy or sell any investment or other specific product. Although all information and opinions expressed in this document were obtained from sources believed to be reliable and in good faith, no warranty, express or implied, is made as to its accuracy or completeness. All information and opinions are subject to change without prior notice. Any information herein are not binding upon any party and cannot constitute any evidence in any court of law.

This catalog may not be reproduced in any form or copies circulated without prior written authority of ALIRA MEDICAL DEVICES LLC

## About us

Alira Medical Devices LLC is a California based Medical Devices' provider that offers a wide range of world-class medical devices and surgical instruments in the fields of Plastic & Reconstructive Surgery, Breast Augmentation, Liposuction, Gynecology, Laparoscopy, Urology, ENT, Ophthalmology and Dentistry to facilitate surgical procedures in a sophisticated manner.

At Alira, we focus on finer details and are aware of every part of the process, and especially, have a willingness to create value for the customer.

We have created an inspiring culture that empowers our people and provides a comfortable, functional, and fun environment that result in a team that works smarter, collaborates, and enjoys what they do.

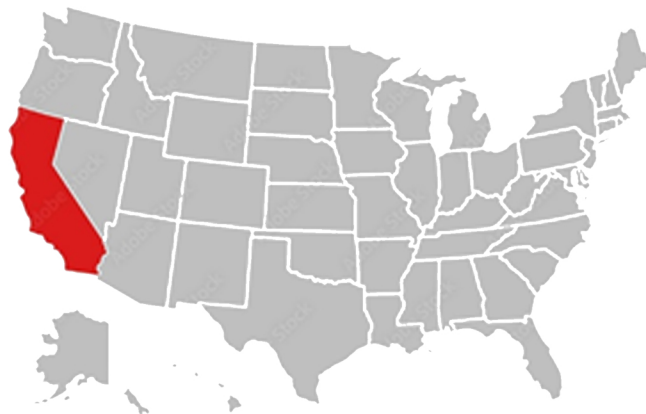

## Quality Focus

Alira Medical Devices is committed to provide top Quality medical devices and surgical instruments to its customers by using a robust Quality Management System (QMS) derived from basic principles laid down by international guidelines e.g. GMP, ISO 13485:2016 & ISO 9001:2016 while meeting statutory/regulatory requirements.

At Alira Medical Devices, Quality begins right from the input materials. All vendors and materials are evaluated for quality & compliance attributes and regulatory requirements through a comprehensive vendor qualification and management program.

To ensure the quality of products, Alira Medical Devices is committed to develop all products following the QBD (Quality by Design) principles and a risk-based scientific approach or as per the regulatory requirements to achieve the quality targets.

Alira Medical Devices is committed to continuously upgrading the equipment and premises to fulfill the compliance requirements and deploy qualified, validated technologies and systems.

Alira Medical Devices promotes the culture of “Speak-up for Quality”, shared learning, transparency, and data integrity. Also ensuring a timely and effective communication and escalation process exists to raise quality issues to the appropriate levels of management, advocating continual improvement

TABLE OF CONTENTS

**06** DENTAL EXTRACTING  
FORCEPS

---

**52** ROOT  
ELEVATORS

---

**75** FILLING  
INSTRUMENTS

---

**86** CURETTES

---

**102** PERIODONTAL  
KNIVES

---

**107** SCALERS

---

**131** CARVERS

---

**139** BONE FILES

---

**143** PLUGGERS

---

**149** FINISHING FILES

---

**152** EXCAVATORS

---

**156** CHISELS &  
OSTEOTOMES

---

**166** ENDODONTIC  
SPREADERS

---

**169** EXPLORERS &  
PROBES

---

**183** BURNISHERS

---

**187** ORTHODONTIC  
PLIERS

---

**206** TONGUE  
DEPRESSORS

---

**211** TOWEL  
CLAMPS

---

**217** MOUTH MIRRORS

---

**222** CEMENT  
SPATULAS

---

**224** MATRIX RETAINERS  
& MATRIX BANDS

---

**229** PLASTER &  
ALGINATE SPATULAS

---

**231** RUBBER DAM  
CLAMPS & FORCEPS

---

**236** CROWN  
REMOVERS

---

## TABLE OF CONTENTS

**243** WAX, PORCELAIN &  
MODELING  
INSTRUMENTS

---

**250** IMPRESSION  
TRAYS

---

**258** PERIOSTEAL  
DENTAL ELEVATORS

---

**267** DENTAL  
SYRINGES

---

**270** MALLETS

---

**274** TWEEZERS &  
FORCEPS

---

**291** WIRE TWISTING  
FORCEPS

---

**297** SCISSORS

---

**314** WIRE CUTTING  
SCISSORS

---

**317** RONGEURS

---

**327** RETRACTORS

---

**348** NEEDLE  
HOLDERS

---

**357** STERILISATION  
CONTAINERS  
& SHEET BASKETS

---

**364** ALPHABETICAL  
INDEX

---

# EXTRACTING FORCEPS

**American Pattern Tooth Extracting Forceps**

SKU	Fig
AAA-2218E	53R For Upper Right Molars
AAA-2313X	18L For Upper Left Molars
AAA-2313Y	18R For Upper Right Molars
AAA-2313Z	53L For Upper Left Molars
AAA-2219A	23 For Lower Molars



AAA-2313X

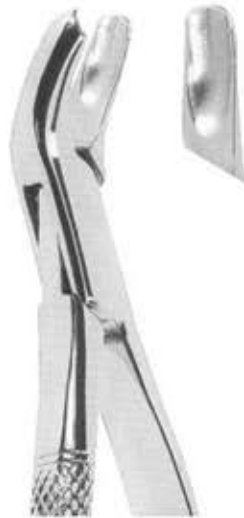

AAA-2313Y



AAA-2219A



AAA-2218E



AAA-2313Z

**American Pattern Tooth Extracting Forceps**

SKU	Fig
AAA-2313V	6 For Separating Forceps
AAA-2313W	105 For Upper Molars
AAA-2219E	17 For Lower Molars



AAA-2313V



AAA-2313W



AAA-2219E

**American Pattern Tooth Extracting Forceps**

SKU	Fig
AAA-2218A	1 For Upper Incisors, Laterals & Cuspids
AAA-2413J	1B For Upper Roots, Anterior
AAA-2413K	5 For Lower Wisdoms
AAA-2413M	10H For Upper Molars



AAA-2218A



AAA-2413J



AAA-2413K



AAA-2413M



**American Pattern Tooth Extracting Forceps**

SKU	Fig
AAA-2413A	65 For Upper Incisors & Roots
AAA-2413C	101 For Deciduous Teeth



AAA-2413A



AAA-2413C

**American Pattern Tooth Extracting Forceps**

SKU	Fig
AAA-2413D	150 For Upper Incisors, Premolars & Roots
AAA-2413F	151 For Upper Incisors, Premolars & Roots
AAA-2413H	222 For Lower Third Wisdoms



AAA-2413D



AAA-2413F



AAA-2413H

**American Pattern Tooth Extracting Forceps**

SKU	Fig
AAA-2218B	10S For Upper Molars
APT-550A	24 For Upper Molars
APT-550B	27 For Upper Molars & Bicuspids
APT-550C	35 For Upper Roots
APT-550R	62 Universal Forceps for Upper Teeth & Roots



APT-550A



APT-550B

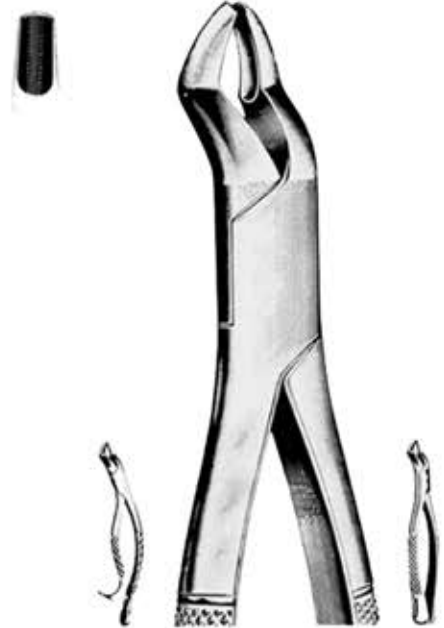

AAA-2218B



APT-550C



APT-550R

**American Pattern Tooth Extracting Forceps**

SKU	Fig
APT-550E	201 For Upper Bicuspids, Cuspids & Incisors
APT-550F	203 For Lower Bicuspids, Incisors & Roots
APT-550G	210H For Upper Wisdoms
APT-550H	210S For Upper Wisdoms
APT-550J	217 For Lower Molars



APT-550E



APT-550F



APT-550G

APT-550H



APT-550J

**American Pattern Tooth Extracting Forceps**

SKU	Fig
APT-550K	286 For Upper Roots, Bicuspids & Incisors
APT-550M	287 For Lower Molars
APT-550N	288 For Lower Bicuspids & Cuspids



APT-550K



APT-550M



APT-550N

**American Pattern Tooth Extracting Forceps - Child**

SKU	Fig
AAA-2413E	150S For Upper Teeth
AAA-2413G	151S For Lower Teeth
ART-2413A	17SK For Lower Molars
ART-2413B	23SK For Lower Molars



ART-2413A



ART-2413B



AAA-2413E



AAA-2413G

**American Pattern Tooth Extracting Forceps - Tomes**

SKU	Fig
AAA-2413B	69 For Upper & Lower Roots



AAA-2413B

**American Pattern Tooth Extracting Forceps - Physick**

SKU	Fig
AAA-2313U	5 For Lower Third Molars



AAA-2313U

**American Pattern Tooth Extracting Forceps - Cowhorn**

SKU	Fig
AAA-2219C	16 For Lower Molars
AAA-2219D	16S For Lower Molars



AAA-2219C



AAA-2219D

**Busch Extracting Forceps**

SKU	Fig
BUS-444N	Narrow Beak
BUS-444W	Resection Forceps For Lower Roots, Wide Beak



BUS-444W



BUS-444N

**Cryer American Pattern Tooth Extracting Forceps**

SKU	Fig
CRY-150	150 For Upper Bicuspids, Incisors, & Roots
CRY-150S	150S For Upper Bicuspids, Incisors, & Roots
CRY-151	151 For Lower Bicuspids, Incisors, & Roots
CRY-151S	151S For Lower Bicuspids, Incisors, & Roots
CRY-151A	151A For Lower Bicuspids, Incisors, & Roots, Modified
CRY-150A	150A For Upper Bicuspids, Incisors, & Roots, Modified



CRY-150S



CRY-151



CRY-150



CRY-150A



CRY-151A



CRY-151S



English Pattern Tooth Extracting Forceps

SKU	Fig
AAA-2213C	13 For Lower Premolars
AAA-2213D	18 For Upper Left Molars
AAA-2313A	8 For Lower Premolars
AAA-2313B	17 For Upper Right Molars
AAA-2313C	18A For Upper Molars



AAA-2313A



AAA-2213C

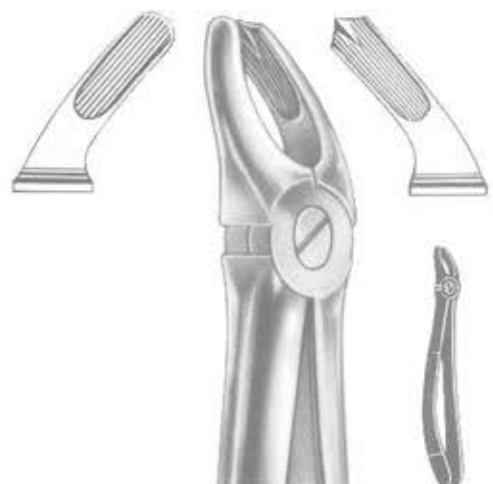

AAA-2313B

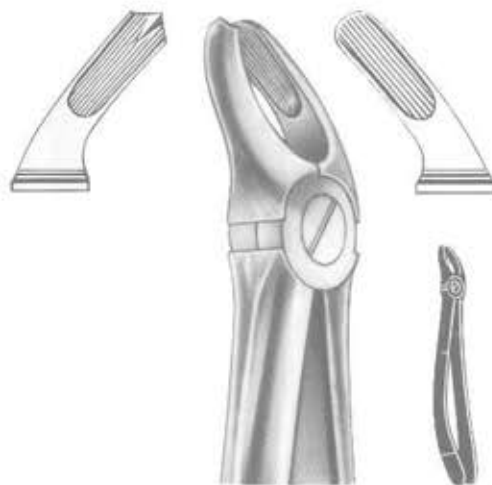

AAA-2213D

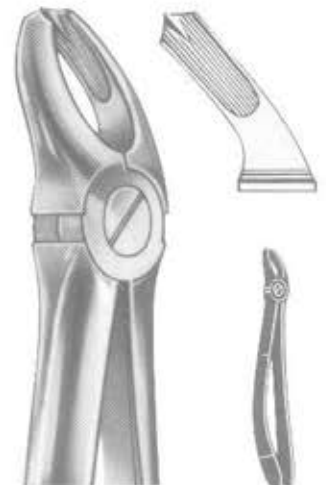

AAA-2313C



English Pattern Tooth Extracting Forceps

SKU	Fig
AAA-2213E	19 For Upper Wisdoms
AAA-2313D	20 For Lower Wisdoms
AAA-2313E	21 For Lower Molars
AAA-2313F	22 For Lower Molars
AAA-2313G	22A For Albrecht Lower Molars

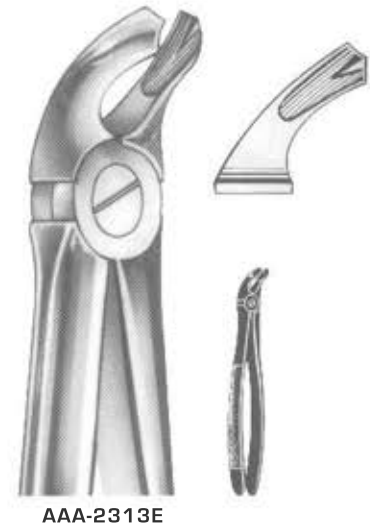
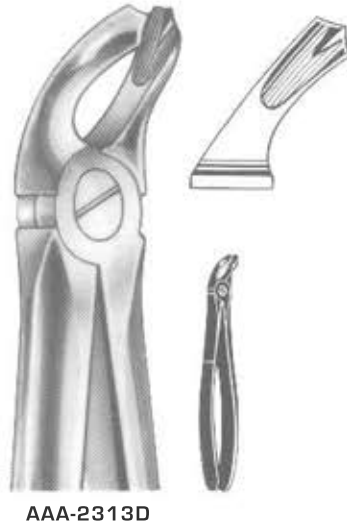

English Pattern Tooth Extracting Forceps

SKU	Fig	Tip
AAA-2313H	33A For Lower Roots	
AAA-2313J	33B For Lower Roots	
AAA-2313K	33L For Lower Roots	
AAA-2313L	33L For Lower Roots	Serrated



AAA-2313H

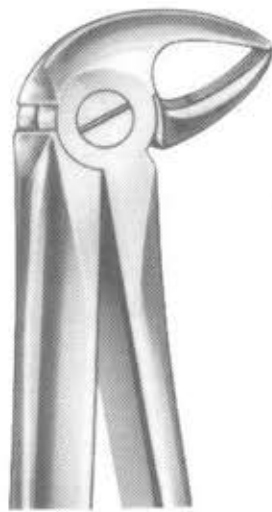

AAA-2313J



AAA-2313K



AAA-2313L

English Pattern Tooth Extracting Forceps

SKU	Fig	Tip
AAA-2313N	51A For Upper Roots	
AAA-2313O	12 For Upper Roots	
AAA-2313P	51L For Upper Roots	
AAA-2213Q	45 For Lower Roots	Serrated



AAA-2213Q



AAA-2313O



AAA-2313N



AAA-2313P

English Pattern Tooth Extracting Forceps

SKU	Fig	Tip
AAA-2213M	43A For Upper Decayed and Fractured Teeth	Serrated
AAA-2213R	46 For Lower Roots	Serrated
AAA-2213S	46L For Lower Roots	Serrated
AAA-2213N	44 For Upper Roots	Serrated



AAA-2213M



AAA-2213N



AAA-2213R



AAA-2213S

English Pattern Tooth Extracting Forceps

SKU	Fig	Tip
AAA-2213T	59 For Lower Roots	Serrated
AAA-2213U	59L For Lower Roots	Serrated
AAA-2213V	60 For Lower Roots	Serrated
EEP-0100A	65L For Upper Left Molars	Serrated
EEP-0100C	65R For Upper Right Molars	Serrated



AAA-2213T



AAA-2213U



AAA-2213V



EEP-0100A



EEP-0100C



English Pattern Tooth Extracting Forceps

SKU	Fig	Tip
AAA-2213W	68 For Lower Roots	Serrated
EEP-0100B	66L For Upper Left Molars	Serrated
EEP-0100Z	66R For Upper Right Molars	Serrated
EEP-0100E	67 For Upper Third Molars	Serrated
EEP-0100F	67A For Upper Third Molars	Serrated



EEP-0100B



EEP-0100Z



EEP-0100E



EEP-0100F



AAA-2213W

English Pattern Tooth Extracting Forceps

SKU	Fig	Tip
AAA-2213X	73 For Lower Roots	Serrated
AAA-2213Y	74 For Lower Roots	Serrated
AAA-2213Z	74M For Lower Roots	Serrated
EEP-0100H	67.5L For Upper Third Left Molars	Serrated
EEP-0100J	67.5R For Upper Third Right Molars	Serrated



EEP-0100H



EEP-0100J



AAA-2213X

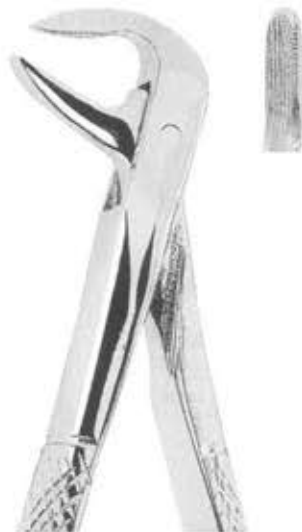

AAA-2213Y



AAA-2213Z



English Pattern Tooth Extracting Forceps

SKU	Fig	Tip
AAA-A2213	74N For Lower Roots	Serrated
EEP-0100K	75 For Lower Bicuspid & Canines	Serrated
EEP-0100L	79 For Lower Third Molars	Serrated
EEP-0100M	79A For Lower Third Molars	Serrated
EEP-0100N	79C For Lower Third Molars	Serrated



AAA-A2213



EEP-0100K



EEP-0100L



EEP-0100M



EEP-0100N

English Pattern Tooth Extracting Forceps

SKU	Fig	Tip
EEP-0101A	86W For Lower Third Molars	Serrated
EEP-0100P	86.5L For Lower Third Left Molars	Serrated
EEP-0100Q	86.5R For Lower Third Right Molars	Serrated
EEP-0100R	86C For Lower Molars	Serrated
EEP-0100U	99 For Broken Down Lower Molars	Serrated
EEP-0100W	107 For Upper Canines	Serrated



EEP-0100U



EEP-0100W



EEP-0100Q



EEP-0101A



EEP-0100R



EEP-0100P



English Pattern Tooth Extracting Forceps

SKU	Fig	Tip
AAA-A2214	151.5 For Upper Roots	Serrated
AAA-B2214	145 For Lower Roots	Serrated
AAA-2313S	166 Universal Extracting Forceps For Upper Teeth, in Particular Molars and Premolars	Serrated
AAA-2313T	167 Universal Extracting Forceps For Lower Teeth, in Particular Molars and Premolars	Serrated
EEP-0100G	121 For Upper Wisdom with Special Beak	Serrated



EEP-0100G



AAA-B2214



AAA-A2214



AAA-2313S



AAA-2313T

English Pattern Tooth Extracting Forceps

SKU	Fig	Tip
AAA-2213P	349 For Upper Roots	Serrated
AAA-C2215	346 For Lower Roots	Serrated
AAA-D2216	359 For Lower Roots	Serrated
EEP-0100X	168 For Upper Canines	Serrated
EEP-0100Y	169 For Lower Canines	Serrated



EEP-0100X



EEP-0100Y

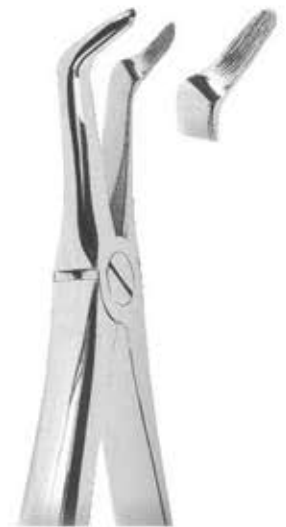

AAA-C2215



AAA-2213P



AAA-D2216

English Pattern Tooth Extracting Forceps

SKU	Fig
AAA-2213F	29 For Upper Roots
AAA-2423K	30 For Upper Roots & Incisors
AAA-2423L	31 For Lower Roots
AAA-2423M	32 For Lower Molars with Decayed Crowns

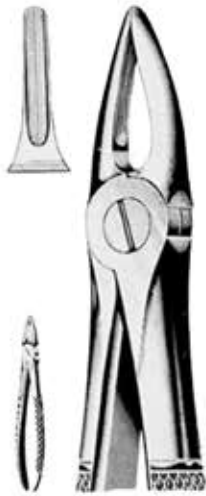

AAA-2213F



AAA-2423M

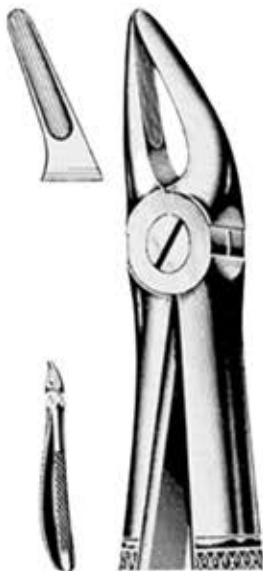

AAA-2423K

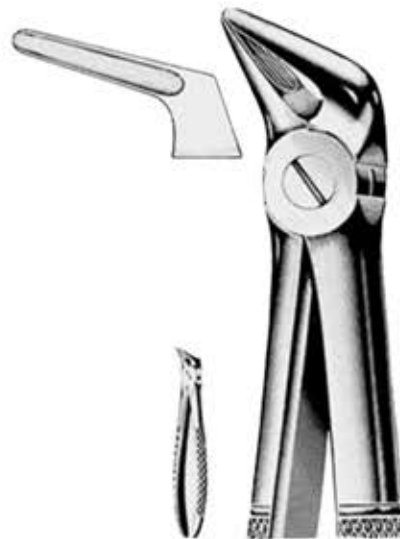

AAA-2423L

English Pattern Tooth Extracting Forceps

SKU	Fig
AAA-2213H	94 For Upper Right Molars
AAA-2213J	95 For Upper Left Molars
AAA-2213K	101 For Upper Molars & Roots
AAA-2213L	113 For Upper Roots
AAA-2423D	24 For Lower Left Molars
AAA-2423E	29N For Roots of Upper Incisors



AAA-2213H

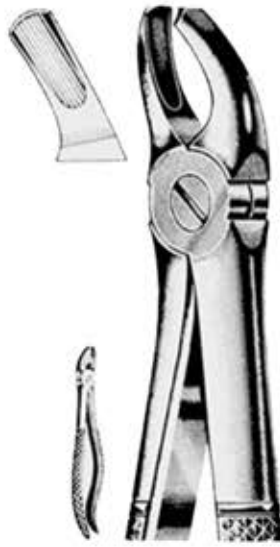

AAA-2213J



AAA-2213L



AAA-2423E



AAA-2423D



AAA-2213K

English Pattern Tooth Extracting Forceps

SKU	Fig
AAA-2423F	1 For Upper Centrals & Canines
AAA-2423G	2 For Upper Laterals & Bicuspids
AAA-2423H	3 For Upper Incisors & Canines Crowded Externally & Internally
AAA-2423J	4 Lower Incisors & Canines
AAA-2423N	7 For Upper Bicuspids



AAA-2423F



AAA-2423G



AAA-2423H



AAA-2423J



AAA-2423N

English Pattern Tooth Extracting Forceps

SKU	Fig
AAA-2423P	51A For Upper Roots, with Narrow Beak
AAA-2423Q	51C For Upper Roots
AAA-2423R	51L For Upper Roots, with Beak for Deep Upper Roots
AAA-2423S	51M For Upper Roots, with Beak for Deep Upper Roots
AAA-2423T	52 For Upper Roots & Canines, with Wide Beak
AAA-2423U	52A For Upper Roots & Resection



AAA-2423P



AAA-2423Q



AAA-2423R



AAA-2423S



AAA-2423T



AAA-2423U



English Pattern Tooth Extracting Forceps

SKU	Fig
AAA-530A	53 For Upper Roots
AAA-2423V	55 For Separating Upper Molar Roots
AAA-2423W	56 For Separating Lower Molar Roots
AAA-2423X	86A For Lower Molars with Decayed Crowns
AAA-2423Y	86B For Lower Molars with Decayed Crowns



AAA-530A



AAA-2423V



AAA-2423W



AAA-2423X



AAA-2423Y

English Pattern Tooth Extracting Forceps

SKU	Fig
AAA-2423Z	76 For Upper Roots
AAA-2424A	76N For Upper Roots, with Narrow Beak
AAA-2424D	233 For Lower Roots, with Parallel Beaks
AAA-2424E	235 For Upper Roots, with Parallel Beaks



AAA-2423Z



AAA-2424A



AAA-2424D



AAA-2424E



English Pattern Tooth Extracting Forceps - Child

SKU	Fig
AAA-2424F	13S For Lower Bicuspid
AAA-2424G	22S For Lower Molars
AAA-2424H	29S For For Upper Roots & Incisors
AAA-2424K	39A For Upper Molars
AAA-2424L	40 For Lower Molars



AAA-2424H



AAA-2424G



AAA-2424F



AAA-2424K



AAA-2424L

English Pattern Tooth Extracting Forceps - Child

SKU	Fig	Tip
AAA-2313Q	37 For Upper Incisors	Serrated
AAA-2313R	51S For Upper Roots	Serrated
AAA-2217E	39 For Upper Molars	Serrated
AAA-2217F	39L For Left Upper Molars	Serrated
AAA-2217G	39R For Right Molars	Serrated



AAA-2313Q



AAA-2217E



AAA-2217G



AAA-2217F



AAA-2313R

English Pattern Tooth Extracting Forceps - Child

SKU	Fig
AAA-2217H	6 For Lower Molars
AAA-2217J	5 For Lower Incisors
AAA-2217K	139 For Upper Premolars
AAA-2217M	137 For Upper Incisors



AAA-2217M



AAA-2217H



AAA-2217J

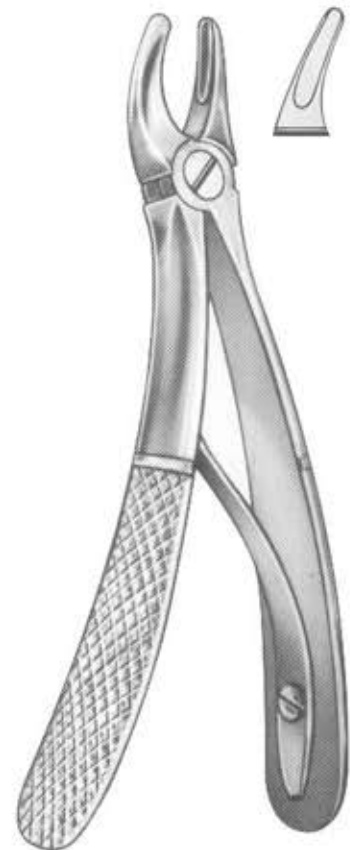

AAA-2217K

English Pattern Tooth Extracting Forceps - Child

SKU	Fig	Tip
AAA-2413N	135 For Lower Premolars	Serrated
AAA-2413P	225 For Lower Molars	
AAA-2413Q	305 For Upper Incisors & Roots	
AAA-2413R	33S For Lower Incisors & Roots	Serrated
AAA-2413S	38 For Lower Incisors & Canines	Serrated



AAA-2413N



AAA-2413P



AAA-2413Q



AAA-2413R



AAA-2413S

**English Pattern Tooth Extracting Forceps - Cowhorn**

SKU	Fig	Tip
EEP-0100S	89 Upper Molars Right	Serrated
EEP-0100T	90 Upper Molars Left	Serrated
EEP-0100V	87 Broken Down Lower Crown	Serrated
AAA-2215A	86 For Lower Molars	



EEP-0100V



EEP-0100S



EEP-0100T



AAA-2215A

**English Pattern Tooth Extracting Forceps - Guys**

SKU	Fig
AAA-2424B	136 For Upper Incisors & Roots
AAA-2424C	137 For Lower Incisors & Roots



AAA-2424B

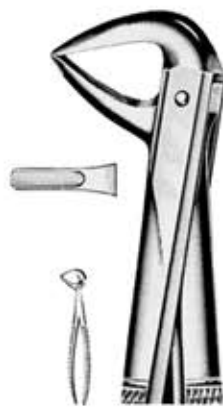

AAA-2424C

**Extracting Forceps With Anatomically Shaped Handle**

SKU	Fig	Tip
ARF-0300A	1 For Upper Incisors & Canines	Serrated
ARF-0300B	2 For Upper Incisors & Canines	Serrated
ARF-0100G	4 For Lower Incisors & Canines	Serrated
ARF-0100E	13 For Lower Premolars	Serrated
ARF-0100F	7 For Upper Premolars	Serrated



ARF-0300A

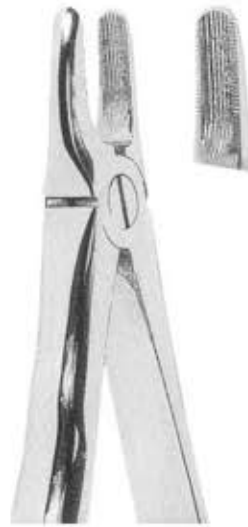

ARF-0300B



ARF-0100G



ARF-0100F



ARF-0100E



**Extracting Forceps With Anatomically Shaped Handle**

SKU	Fig	Tip
ARF-0400A	17 For Right Upper Molar	Serrated
ARF-0400C	18 For Left Upper Molar	Serrated
ARF-0500A	21 For Lower Molar	Serrated
ARF-0500B	22 For Lower Molar	Serrated
ARF-0800A	33 For Lower Roots	Serrated
ARF-0400B	89 For Upper Right Molars	Serrated
ARF-0400E	90 For Left Upper Molars	Serrated
ARF-0700A	151.5 For Upper Roots	Serrated
ARF-0700B	349 For Upper Roots	Serrated
ARF-0800B	145 For Lower Roots	Serrated



ARF-0400A



ARF-0400C



ARF-0500A



ARF-0500B



ARF-0800A



ARF-0400E



ARF-0400B



ARF-0700B



ARF-0800B



ARF-0700A



Extracting Forceps With Anatomically Shaped Handle

SKU	Fig	Tip
ARF-0600A	67A For Upper Third Molar	Serrated
ARF-0600B	79 For Lower Third Molar	Serrated
ARF-0600C	86C For Lower Molars	Serrated
ARF-0700C	51A For Upper Roots	Serrated
ARF-0800C	45 For Lower Roots	Serrated
ARF-0800F	74 For Lower Roots	Serrated
ARF-0800E	359 For Lower Roots	Serrated

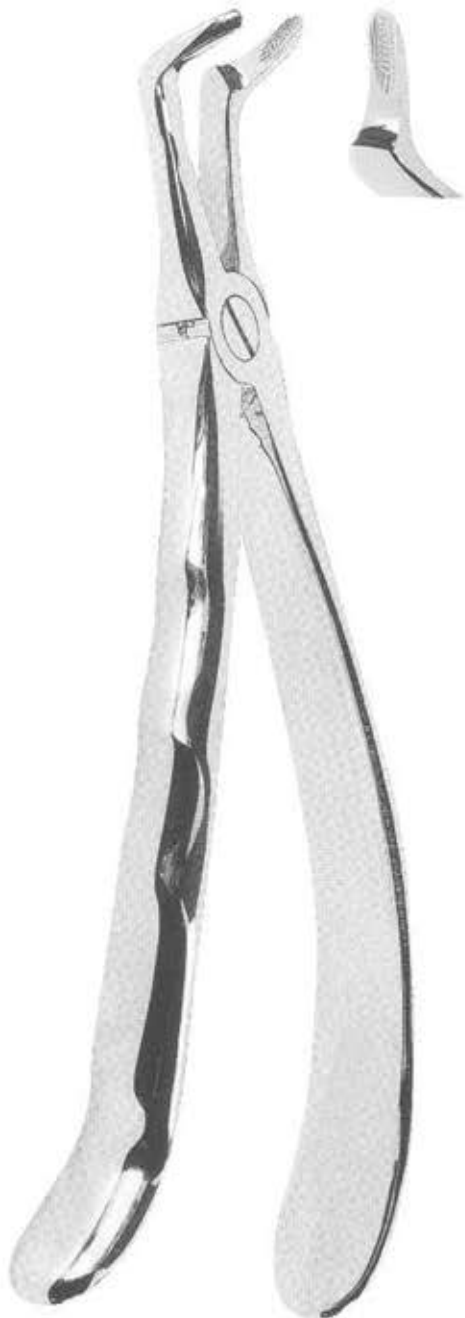

ARF-0800C



ARF-0700C



ARF-0600A



ARF-0800F



ARF-0600B



ARF-0600C



ARF-0800E

**Henahan American Pattern Tooth Extracting Forceps**

SKU	Fig
HENP-01A	1A For Upper Incisors



HENP-01A

**Hull American Pattern Tooth Extracting Forceps**

SKU	Fig
HAPTE-A101	101 For Upper & Lower Premolars



HAPTE-A101

**Kells American Pattern Tooth Extracting Forceps**

SKU	Fig
KAPTE-A101	99C For Upper Incisors, Canines & Premolars



KAPTE-A101

**Klein Pattern Tooth Extracting Forceps**

SKU	Fig	Tip
AAA-2413T	1 For Upper Incisors	Serrated
AAA-2413U	2 For Upper Premolars	Serrated
AAA-2413V	3 For Upper Molars	Serrated
AAA-2413W	4 For Upper Roots	Serrated
AAA-2413X	5 For Lower Incisors	Serrated
AAA-2413Y	6 For Lower Molars	Serrated
AAA-2413Z	7 For Lower Roots	Serrated



AAA-2413T



AAA-2413U



AAA-2413V



AAA-2413W



AAA-2413X



AAA-2413Y



AAA-2413Z

**Klein Pattern Tooth Extracting Forceps**

SKU	Fig
AAA-2423A	137 For Upper Incisors & Canines
AAA-2423B	139 For Upper Bicuspids
AAA-2423C	51S For Lower Molars



AAA-2423A



AAA-2423B



AAA-2423C

**Lawrence Read Forceps - Child**

SKU	Fig
LRF- 76S	76S For Upper Roots



LRF- 76S

**Mead Pattern Extraction Forceps**

SKU	Fig	Tip
MEP-0100A	MD 1 For Upper Wisdoms, Bicuspid & Upper Roots	Serrated
MEP-0100B	MD 2 For Upper Molars	Serrated
MEP-0100C	MD 3 For Lower Incisors, Bicuspid & Roots	Serrated
MEP-0100E	MD 4 For Lower Molars	Serrated



MEP-0100A



MEP-0100B



MEP-0100E

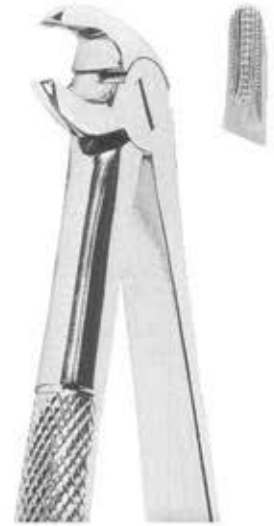

MEP-0100C

**Nevius American Pattern Tooth Extracting Forceps**

SKU	Fig
NAP-88R	88R For Upper Right Molars
NAP-88L	88L For Upper Left Molars
NAP-10H	10H For Upper Cuspids & Bicuspids
NAP-10S	10S For Upper Cuspids & Bicuspids



NAP-88L



NAP-88R



NAP-10H

NAP-10S

**Milwaukee American Pattern Tooth Extracting Forceps**

SKU	Fig
MWA-03F	3 For Lower Bicuspids



MWA-03F

**Parmly Alveolar American Pattern Tooth Extracting Forceps**

SKU	Fig
AAA-2220A	32 For Premolars, Molars & Upper Canines
AAA-2220B	32A For Premolars, Molars & Upper Canines, Narrow Beaks



AAA-2220A AAA-2220B



**Relax Extracting Forceps**

SKU	Fig
ARF-0100A	51 For Upper Roots
ARF-0100B	51A For Upper Roots
ARF-0100C	51L For Upper Roots
ARF-0200A	67 For Upper Wisdoms
ARF-0200B	67A For Upper Wisdoms



ARF-0100A



ARF-0100B



ARF-0100C



ARF-0200A



ARF-0200B



**Root Splinter Extracting Forceps**

SKU	Fig	Tip
RSF-0100A	1 For Lower Roots	Serrated
RSF-0100C	2 For Upper Roots	Serrated
RSF-0100E	2 For Roots Fragments	
RSF-0100B	1 For Roots Fragments	



RSF-0100A



RSF-0100C



RSF-0100B



RSF-0100E

**Routurier Extracting Forceps**

SKU	Fig
ARF-444L	For Lower Wisdoms & Molars - Left Shape
ARF-444R	For Lower Wisdoms & Molars - Right shape



ARF-444L



ARF-444R

**Stiksa Extracting Forceps**

SKU	Fig
STF-444R	For Roots of Lower Molars & Wisdoms
STF-444L	For Lower Wisdoms & Molars



STF-444L



STF-444R

**Thomas American Pattern Tooth Extracting Forceps**

SKU	Fig
THA-85F	85 Alveolar Forceps for Lower Molars, Cuspids & Bicuspids
THA-85A	85A Alveolar Forceps for Lower Molars, Cuspids & Bicuspids



THA-85F

THA-85A

**Witzel Root Fragment Forceps**

SKU	Fig
WRF-111U	For Upper Teeth
WRF-111L	For Lower Teeth

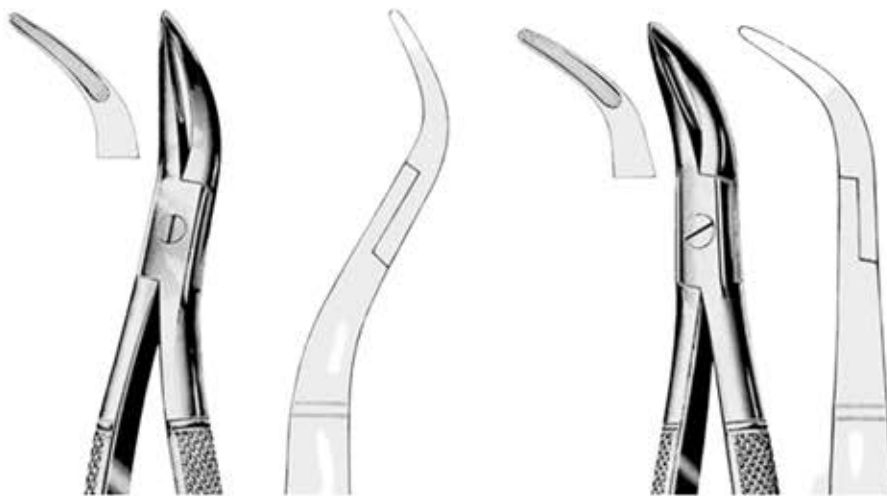

WRF-111U

WRF-111L

Woodward American Pattern Tooth Extracting Forceps

SKU	Fig
WAP-3FH	3FH For Lower Molars
WAP-3FS	3FS For Lower Molars

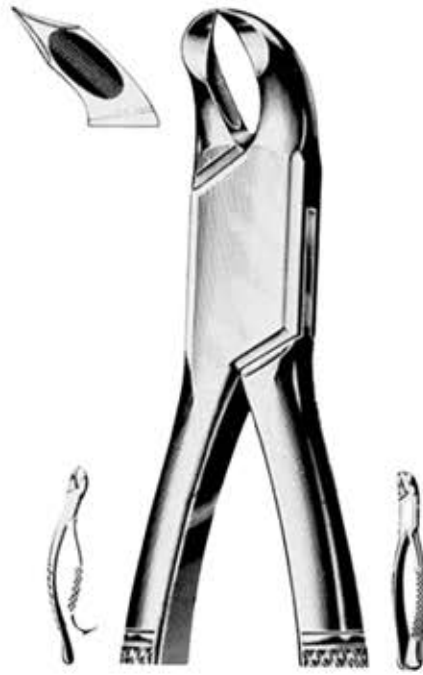

WAP-3FH

WAP-3FS

# ROOT ELEVATORS

**Apexo Root Elevator**

SKU	Fig
AAA-2193A	301
AAA-2193B	302
AAA-2193C	303
AAA-2193D	304



AAA-2193B



AAA-2193A



AAA-2193C



AAA-2193D

**Apical Root Elevator**

SKU	Fig
ARE-100A	1
ARE-100B	2
ARE-100C	3
ARE-100E	4



ARE-100A



ARE-100B



ARE-100C



ARE-100E



**Barry Root Elevator**

SKU	Fig
BE-R10A	1
BE-R10B	2
BE-R10C	3
BE-R10C2	4
BE-R10H	11
BE-R10E	12
BE-R10F	17
BE-R10G	18



BE-R10H



BE-R10E



BE-R10A



BE-R10B



BE-R10C



BE-R10C2



BE-R10F



BE-R10G

**Bein Root Elevator**

SKU	Fig
BRE-100A	0
BRE-100B	1
BRE-100C	2
BRE-100M	3
BRE-100E	4
BRE-100F	5
BRE-100G	6



BRE-100B



BRE-100C



BRE-100A



BRE-100M



BRE-100E



BRE-100F



BRE-100G

**Bein Root Elevator - Bayonet Mesial**

SKU	Fig
BRE-100H	1
BRE-100J	2
BRE-100K	3
BRE-100L	4



BRE-100H



BRE-100J



BRE-100K



BRE-100L

**Chompret Root Elevator**

SKU	Fig
CE-R10A	1
CE-R10B	2
CE-R10C	3
CE-R10E	4



CE-R10A



CE-R10B



CE-R10C



CE-R10E

**Coupland Elevator**

SKU	Fig
AAA-2198A	1
AAA-2198B	2
AAA-2199C	3

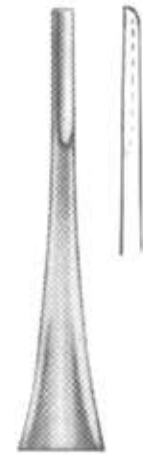

AAA-2198A

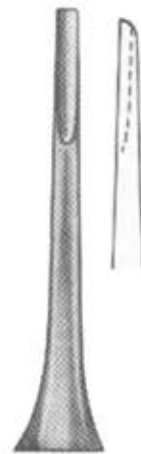

AAA-2198B



AAA-2199C

**Crane Pick Root Elevator**

SKU	Fig
AAA-2199A	8



AAA-2199A

**Cryer Root Elevator**

SKU	Fig
AAA-2500C	3
AAA-2500Z	4
AAA-2500E	12
AAA-2500F	27
AAA-2500G	28
AAA-2500H	27S
AAA-2500J	28S



AAA-2500C



AAA-2500Z



AAA-2500E



AAA-2500F



AAA-2500G



AAA-2500H



AAA-2500J

**Cryer Root Elevator**

SKU	Fig
AAA-2500K	1
AAA-2500L	2
AAA-2194F	26
AAA-2194G	28
AAA-2194H	29



AAA-2500K



AAA-2500L



AAA-2194F



AAA-2194G



AAA-2194H



**Cryer Root Elevator Handle**

SKU
CRH-100A



CRH-100A

**Curtis Root Elevator**

SKU	Fig
CRE-100A	51
CRE-100B	52



CRE-100A

CRE-100B

**Flohr Root Elevator**

SKU	Fig
FRE-100A	1
FRE-100B	2
FRE-100C	3



FRE-100A



FRE-100B

FRE-100C



**Friedman Root Elevator**

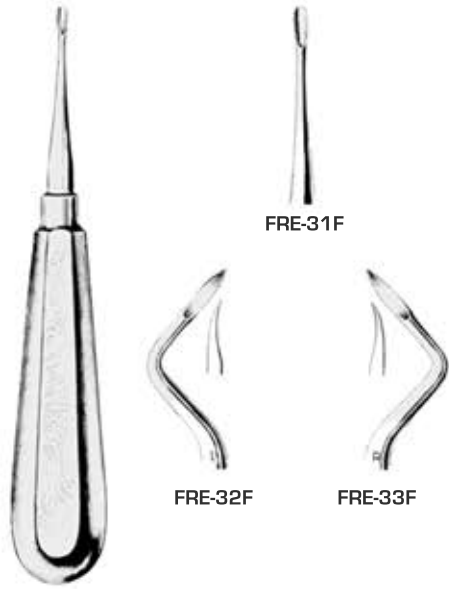

SKU	Fig
FRE-31F	1
FRE-32F	2
FRE-33F	3

**Heidbrink Root Elevator**

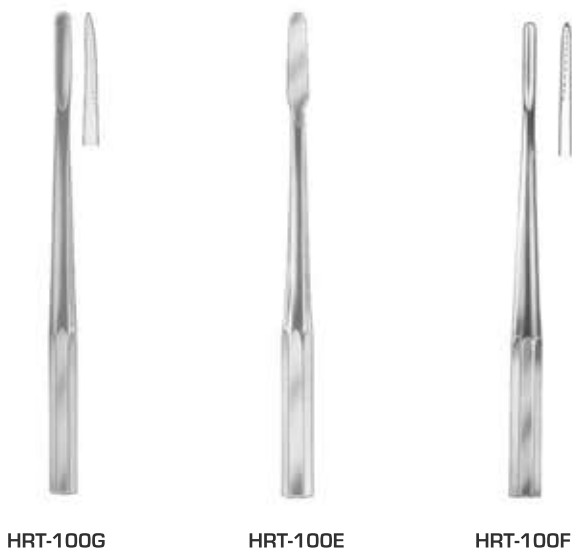

SKU	Fig
HRT-100G	22
HRT-100E	23
HRT-100F	10

**Heidbrink Root Elevator**

SKU	Fig
AAA-2195A	1
AAA-2195B	2
AAA-2195E	3
AAA-2195C	40
AAA-2195D	41



AAA-2195A



AAA-2195B



AAA-2195E



AAA-2195C



AAA-2195D

**Hourigan Root Elevator - Serrated**

SKU	Fig
AAA-2207A	H5
AAA-2207B	H6



AAA-2207A



AAA-2207B

**Hulin Root Elevator**

SKU	Fig
HRE-100A	1
HRE-100B	2
HRE-100C	3
HRE-100E	4



HRE-100A



HRE-100B



HRE-100C



HRE-100E

**Kopp Root Elevator**

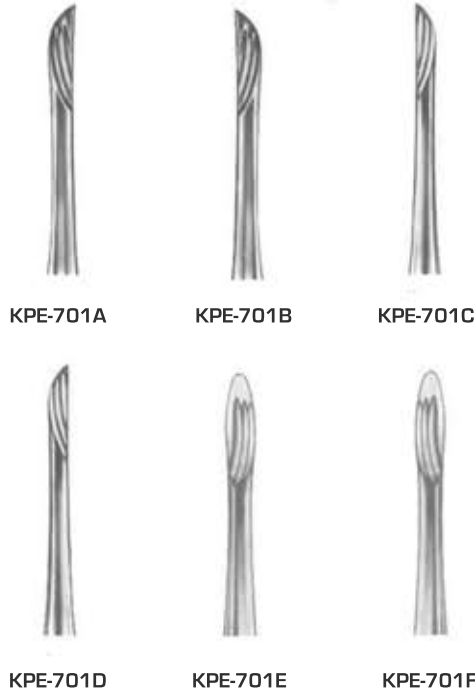

SKU	Fig
KPE-701A	1
KPE-701B	2
KPE-701C	3
KPE-701D	4
KPE-701E	5
KPE-701F	6
KRE-100A	31
KRE-100B	32
KRE-100C	33
KRE-100G	34
KRE-100E	35
KRE-100F	44



**Kopp Root Elevator Handle**

<b>SKU</b>
KRH-100A



KRH-100A

**Kopp Root Elevator - Bayonet**

SKU	Fig
KPE-701G	1
KPE-701J	2
KPE-701K	3
KPE-701L	4



KPE-701G



KPE-701J



KPE-701K



KPE-701L

**Krallenheber Root Elevator**

SKU	Fig
PRT-100C	1
PRT-100E	2



PRT-100C



PRT-100E

**Lecluse Root Elevator**

SKU
LE-R10A



LE-R10A

**London Hospital Elevator**



AAA-2500M



AAA-2500N



AAA-2500P

SKU	Fig
AAA-2500M	1
AAA-2500N	2
AAA-2500P	3

**Loos Root Elevator**



LRE-995



LRE-996



LRE-997



LRE-998

SKU	Fig
LRE-995	1
LRE-996	2
LRE-997	5
LRE-998	6



**Luxator Root Elevator**

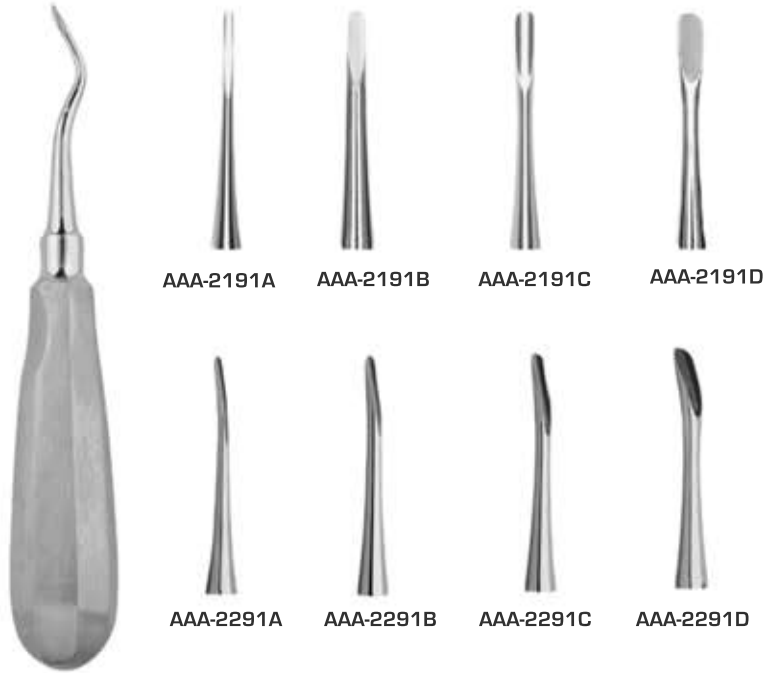

SKU	Fig	Shape
AAA-2191A	2mm	Straight
AAA-2191B	3mm	Straight
AAA-2191C	4mm	Straight
AAA-2191D	5mm	Straight
AAA-2291A	2mm	Curved
AAA-2291B	3mm	Curved
AAA-2291C	4mm	Curved
AAA-2291D	5mm	Curved

**MacMillan Gouge Root Elevator**

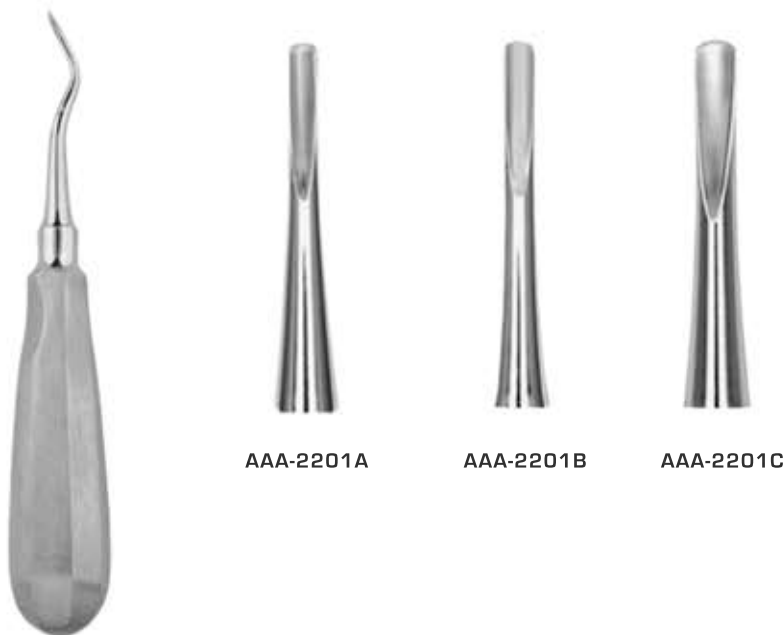

SKU	Fig
AAA-2201A	11M
AAA-2201B	12M
AAA-2201C	13M

**Mead Root Elevator**

SKU	Fig
ME-R10A	MD 1
ME-R10B	MD 5A
ME-R10C	MD 6A
ME-R10F	MD 7A
ME-R10E	MD 8

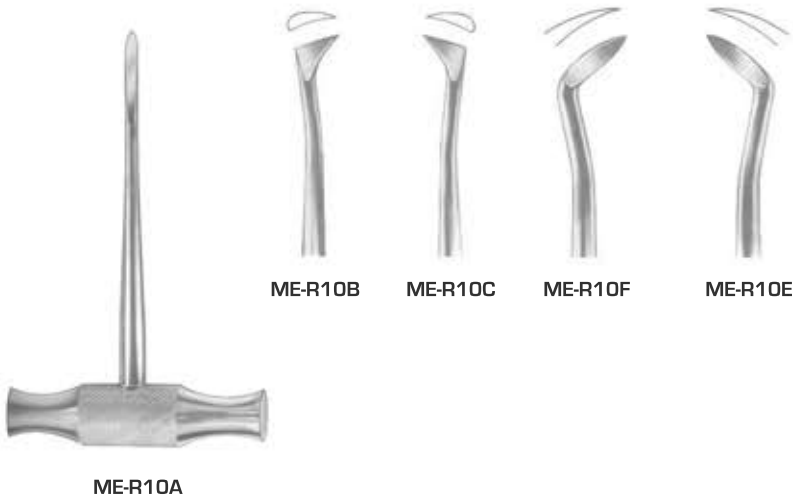

**Miller Root Elevator**

SKU	Fig
AAA-2197A	71
AAA-2197B	72
AAA-2197C	73
AAA-2197D	74



**Pott Root Elevator**



SC-500A



PRT-100A



PRT-100B

SKU	Fig
SC-500A	
PRT-100A	1
PRT-100B	2

**Ratzow Root Elevator**



RAT-100A



RAT-100B



RAT-100C

SKU	Fig
RAT-100A	1
RAT-100B	2
RAT-100C	3

**Seldin Root Elevator**



AAA-2192B



AAA-2192C



AAA-2500A



AAA-2500B

SKU	Fig
AAA-2192B	1L
AAA-2192C	1R
AAA-2500A	2
AAA-2500B	3
AAA-2192G	4L
AAA-2192H	4R
AAA-2192J	34
AAA-2192K	34S
AAA-2192F	27



AAA-2192F



AAA-2192G



AAA-2192H



AAA-2192K



AAA-2192J

**Stout Root Elevator**



AAA-2200A



AAA-2200B

SKU	Fig
AAA-2200A	11
AAA-2200B	11A

**Vignal Root Elevator**

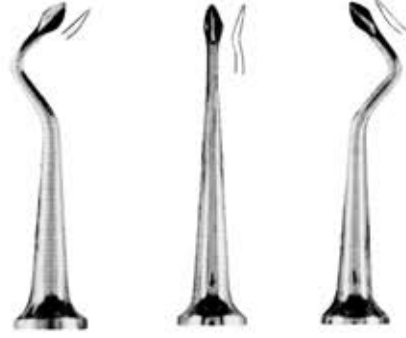

VIG-100A      VIG-100B      VIG-100C

SKU	Fig
VIG-100A	54
VIG-100B	55
VIG-100C	56

**Vignal Root Elevator - Bayonet**

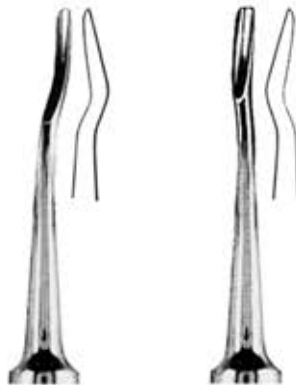

VIG-100F      VIG-100E

SKU	Fig
VIG-100F	57
VIG-100E	69

**Warwick-James Elevator**



AAA-2208B



AAA-2208C



AAA-2208A

SKU	Fig	Shape
AAA-2208A	3	Left
AAA-2208B	1	Straight
AAA-2208C	2	Right

**Woodward Root Elevator**



AAA-2202A



AAA-2202B



SKU	Fig
AAA-2202A	15
AAA-2202B	16

Winter Root Elevator



WE-R10L

WE-R10M



WE-R10G

WE-R10H

SKU	Fig
WE-R10A	1L
WE-R10B	1R
WE-R10C	2L
WE-R10R	2R
WE-R10E	11L
WE-R10F	11R
WE-R10G	11
WE-R10H	12
WE-R10J	12L
WE-R10K	12R
WE-R10L	13L
WE-R10M	13R
WE-R10N	14L
WE-R10P	14R



WE-R10N

WE-R10P



WE-R10A

WE-R10B



WE-R10C

WE-R10R



WE-R10E

WE-R10F



WE-R10J

WE-R10K



# FILLING INSTRUMENTS

Ash Filling Instruments

SKU	Fig
ASH-100A	1
ASH-100B	2
ASH-100C	3
ASH-100S	4
ASH-100E	5
ASH-100F	6
ASH-100G	7
ASH-100H	M
ASH-100J	N
ASH-100K	0
ASH-100L	64
ASH-100M	65
ASH-100N	66
ASH-100P	181
ASH-100Q	182
ASH-100R	183

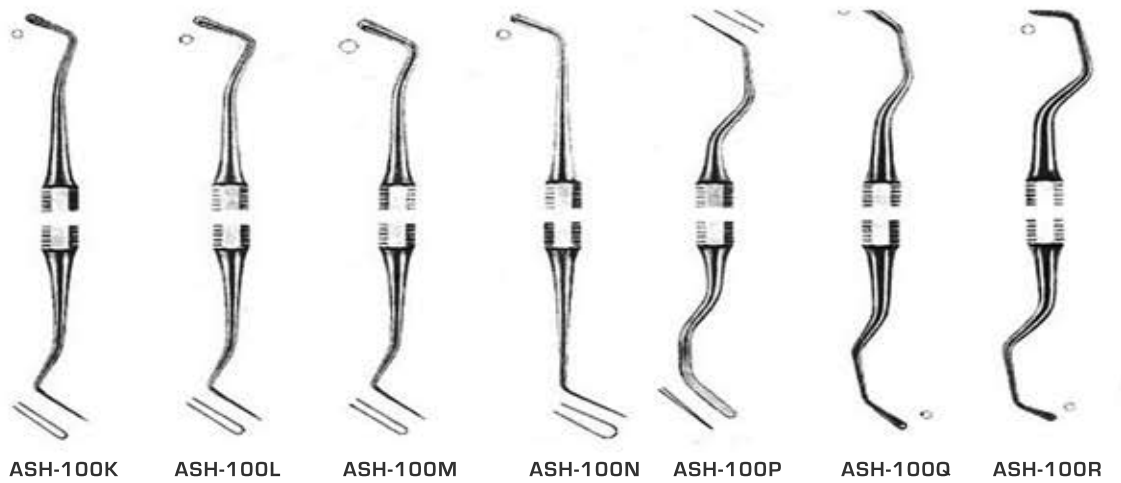
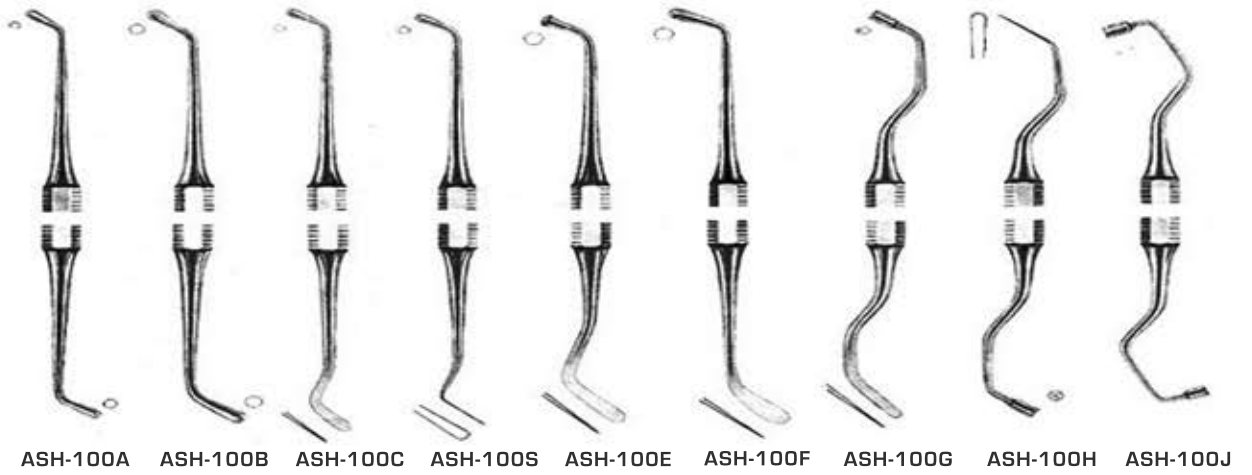

**Bennett Filling Instruments**

SKU	Fig
BFI-10A	7
BFI-10B	10



BFI-10A



BFI-10B

**Dycal Filling Instrument**

SKU	Fig
DYC-20A	20



DYC-20A

**Edwards Filling Instrument**

SKU	Fig
EWF-100	62
EWF-101	63
EWF-102	134

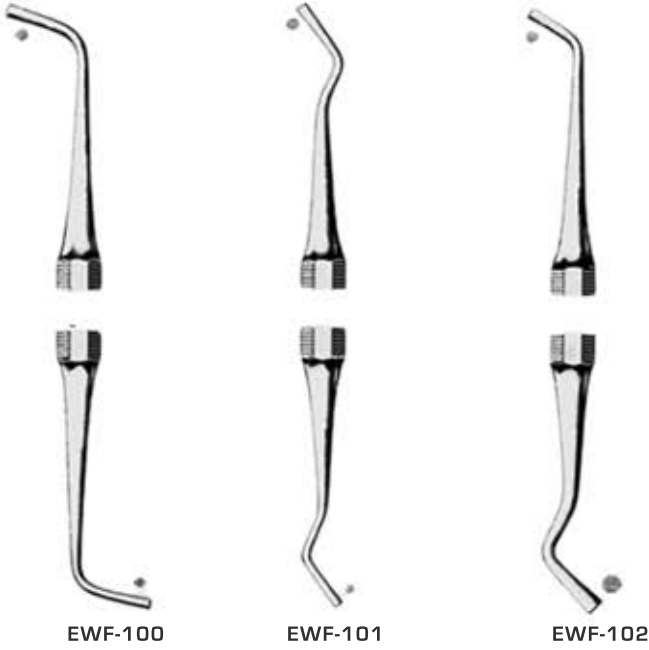

**Heidemann Filling Instruments**

SKU	Fig
HFI-600A	1
HFI-600B	2
HFI-600C	3

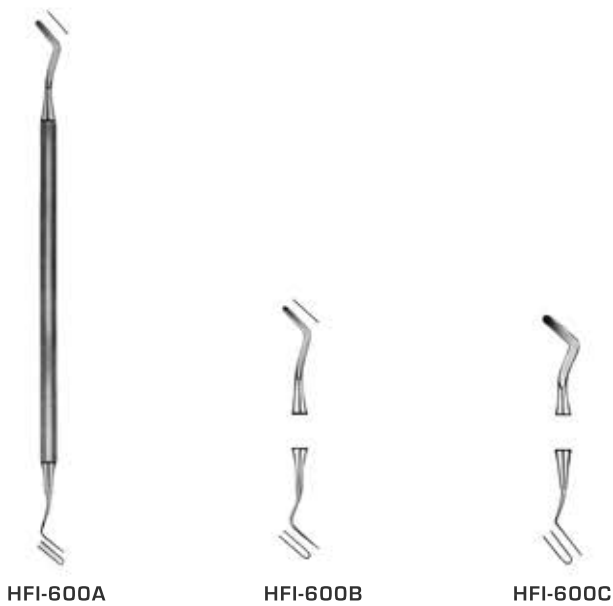

**Ladmore Filling Instrument**

SKU	Fig
LFI-161A	1
LFI-162A	2
LFI-163A	3
LFI-164A	4
LFI-165A	5

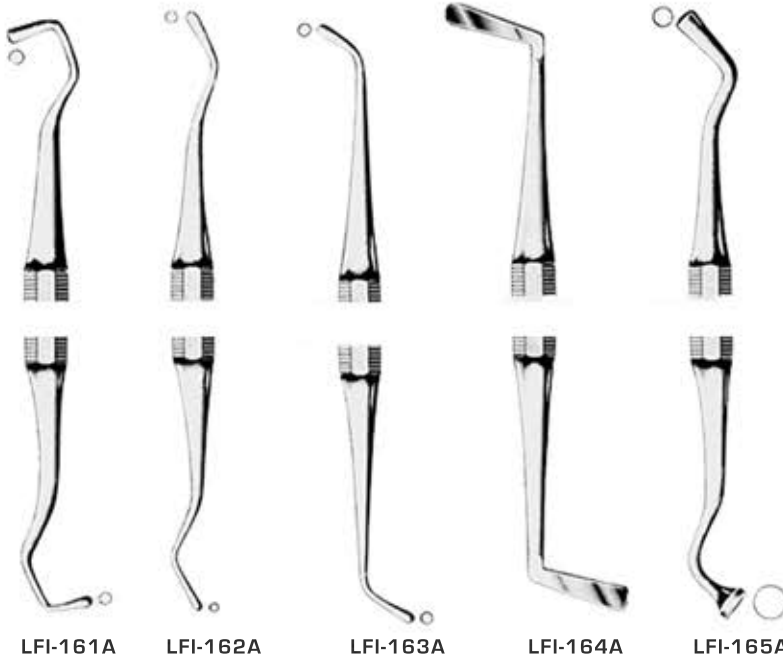

**Linsemann Filling Instrument**

SKU	Fig
LFI-111	1
LFI-112	2
LFI-113	3
LFI-114	4
LFI-115	5
LFI-116	6

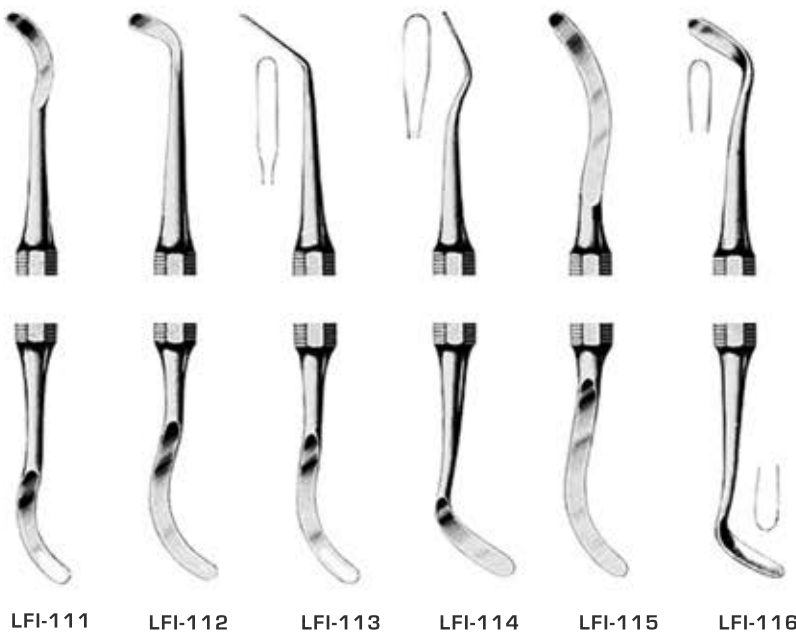

Plastic Filling Instrument - Series 1

SKU	Fig
PFI-1601	0
PFI-170A	1
PFI-170B	2
PFI-170C	3
PFI-170K	4
PFI-170E	5
PFI-170F	6
PFI-170G	7
PFI-170H	8
PFI-170J	9



PFI-1601      PFI-170A      PFI-170B      PFI-170C      PFI-170K      PFI-170E      PFI-170F



PFI-170G      PFI-170H      PFI-170J

Plastic Filling Instrument - Series 2

SKU	Fig
PFI-200A	1
PFI-200B	2
PFI-200C	3
PFI-200S	4
PFI-200E	5
PFI-200F	3A
PFI-200G	4A
PFI-200H	4B
PFI-200J	5A
PFI-200K	5B
PFI-200L	6
PFI-200M	7
PFI-200N	7A
PFI-200P	7B
PFI-200Q	8
PFI-200R	9

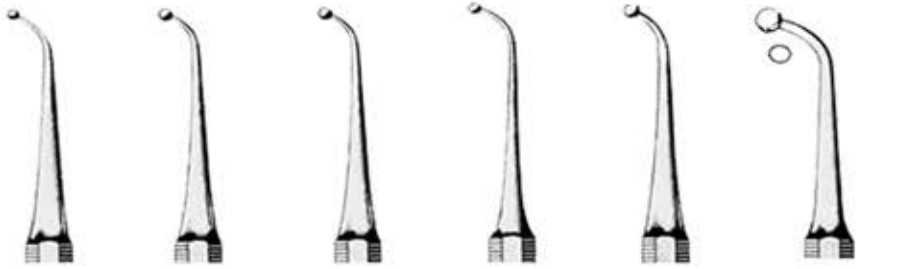

PFI-200A PFI-200B PFI-200C PFI-200F PFI-200S PFI-200G



PFI-200H PFI-200E PFI-200J PFI-200K PFI-200L PFI-200M PFI-200N PFI-200P PFI-200Q PFI-200R



**Plastic Filling Instrument - Series 3, Axial**



PFI-301 PFI-302 PFI-303 PFI-304 PFI-305 PFI-306 PFI-307 PFI-308 PFI-309 PFI-310

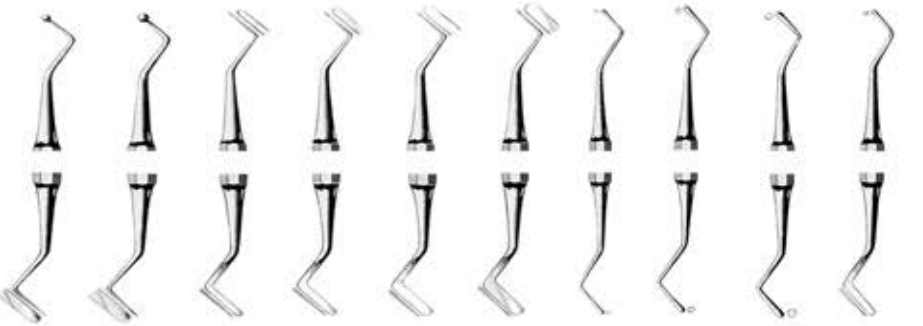

PFI-311 PFI-312 PFI-313 PFI-314 PFI-315 PFI-316 PFI-317 PFI-318 PFI-319 PFI-320

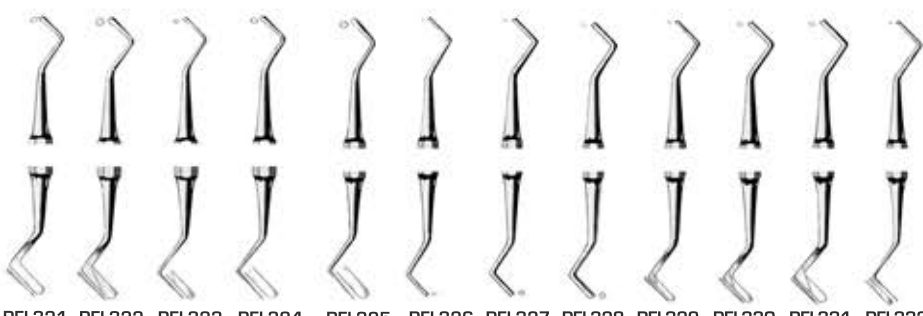

PFI-321 PFI-322 PFI-323 PFI-324 PFI-325 PFI-326 PFI-327 PFI-328 PFI-329 PFI-330 PFI-331 PFI-332

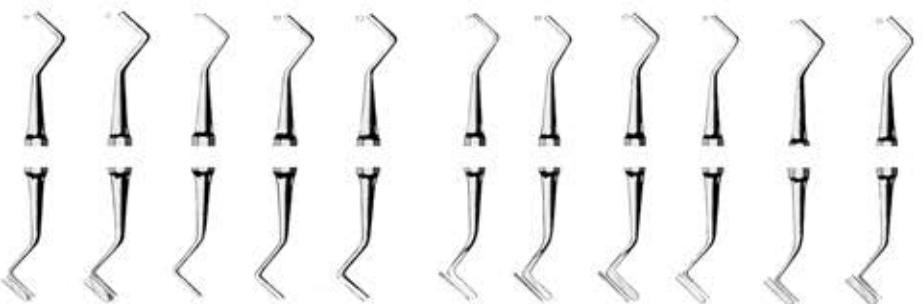

PFI-333 PFI-334 PFI-335 PFI-336 PFI-337 PFI-338 PFI-339 PFI-340 PFI-341 PFI-342 PFI-343

SKU	Fig
PFI-301	1
PFI-302	2
PFI-303	3
PFI-304	4
PFI-305	5
PFI-306	6
PFI-307	7
PFI-308	8
PFI-309	9
PFI-310	10
PFI-311	11
PFI-312	12
PFI-313	13
PFI-314	14
PFI-315	15
PFI-316	16
PFI-317	17
PFI-318	18
PFI-319	19
PFI-320	20
PFI-321	21
PFI-322	22
PFI-323	23
PFI-324	24
PFI-325	25
PFI-326	26
PFI-327	27
PFI-328	28
PFI-329	29
PFI-330	30
PFI-331	31
PFI-332	32
PFI-333	33
PFI-334	34
PFI-335	35
PFI-336	36
PFI-337	37
PFI-338	38
PFI-339	39
PFI-340	40
PFI-341	41
PFI-342	42
PFI-343	43

**Thymozine Filling Instrument**

SKU	Fig
THY-02	2
THY-03	3

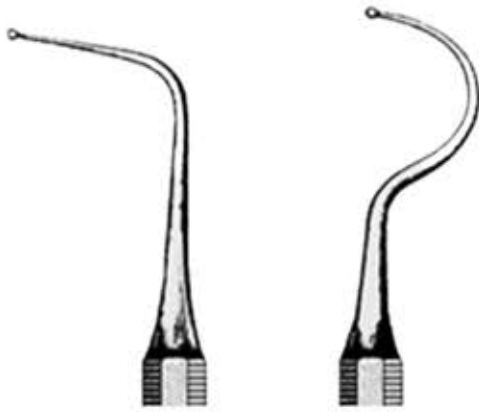

THY-02

THY-03

**Woodson Plastic Filling Instrument**

SKU	Fig
WPFI-17A	1
WPFI-17B	2
WPFI-17C	3

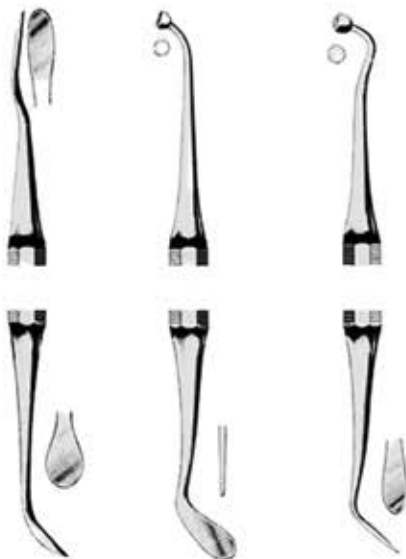

WPFI-17A

WPFI-17B

WPFI-17C

**White Filling Instruments**

SKU	Fig
WFI-900A	1
WFI-900B	2
WFI-900C	3
WFI-900J	4
WFI-900E	5
WFI-900F	6
WFI-900G	2A
WFI-900H	5A



**Williams Filling Instruments**

SKU	Fig
WIL-01A	0
WIL-02A	1
WIL-03A	2
WIL-04A	4

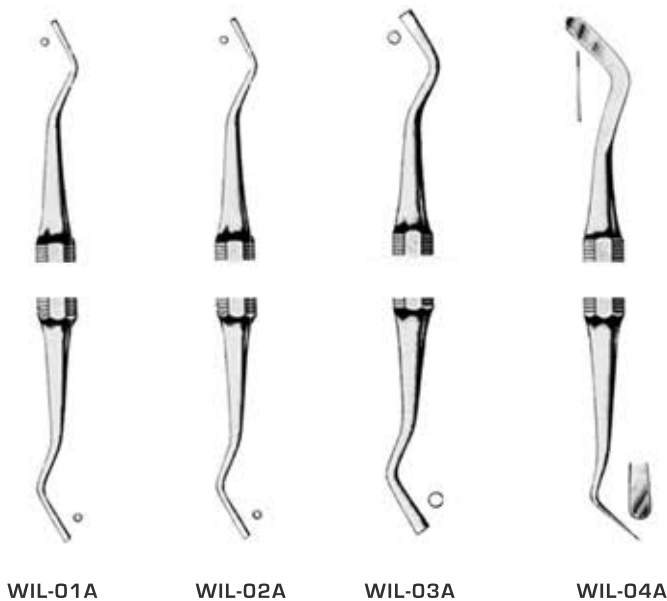

Ward Filling Instrument

SKU	Fig	Tip
WAR-111A	1	Smooth
WAR-111B	2	Smooth
WAR-111C	3	Smooth
WAR-111D	4	Smooth
WAR-111E	5	Smooth
WAR-111F	6	Smooth
WAR-111G	1	Serrated
WAR-111H	2	Serrated
WAR-111J	3	Serrated
WAR-111K	4	Serrated
WAR-111L	5	Serrated
WAR-111M	6	Serrated



WAR-111A Smooth    WAR-111B Smooth    WAR-111C Smooth    WAR-111D Smooth    WAR-111E Smooth    WAR-111F Smooth



WAR-111G Serrated    WAR-111H Serrated    WAR-111J Serrated    WAR-111K Serrated    WAR-111L Serrated    WAR-111M Serrated

# CURETTES

**Chompret Bone Curette**

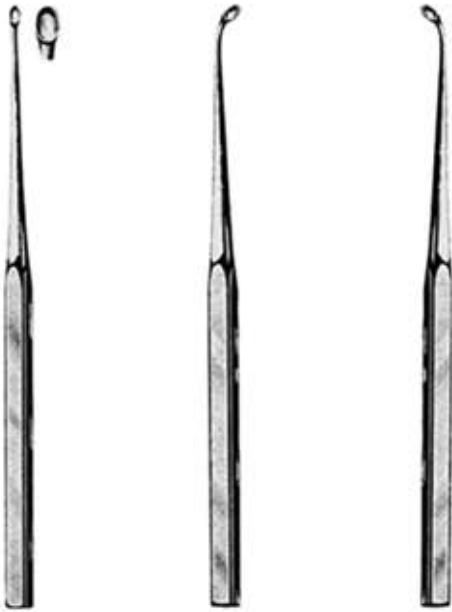

CHM-2102

CHM-2100

CHM-2101

SKU	Shape
CHM-2100	Sharp Left
CHM-2101	Sharp Right
CHM-2102	Sharp Straight

**Columbia Curette**

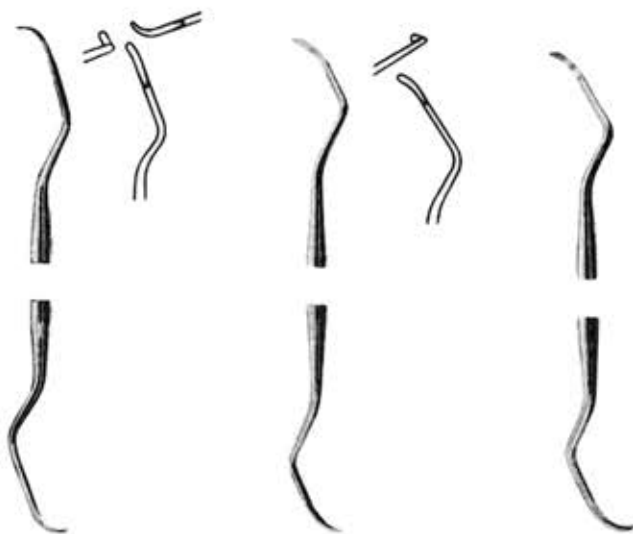

CC-F22

CC-F44

CC-F34

SKU	Fig
CC-F22	2R/2L
CC-F34	13/14
CC-F44	4R/4L

Crane Kaplan Curette

SKU	Fig
CK-C060	6
CK-C061	6S

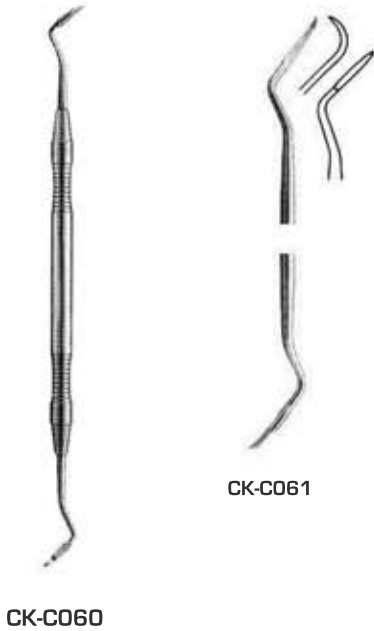

Goldman-Fox Curette

SKU	Fig
CG-F10	1
CG-F20	2
CG-F30	3
CG-F40	4
CG-F50	5
CG-F60	21

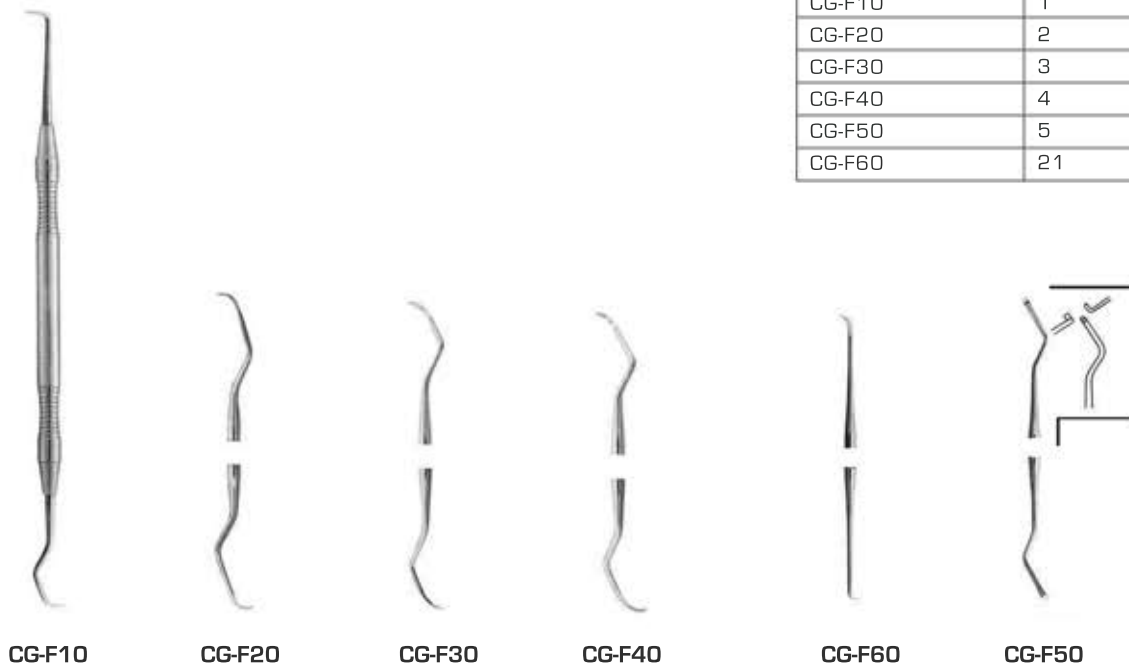

**Gracey Mesial Distal Curette**

SKU	Fig
CG-F350	11/14
CG-F360	12/13



**Gracey Curette**

SKU	Fig
CG-F110	1/2
CG-F120	3/4
CG-F130	5/6
CG-F140	7/8
CG-F150	9/10
CG-F160	11/12
CG-F170	13/14

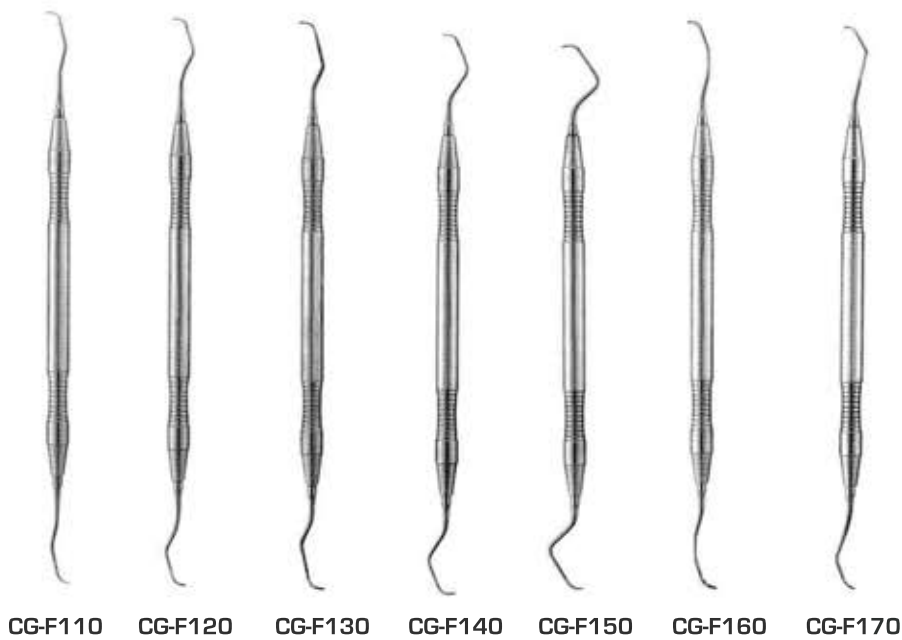



**Gracey Curette**

SKU	Fig	Type
CG-F180	1/2	AF
CG-F190	3/4	AF
CG-F200	5/6	AF
CG-F210	7/8	AF
CG-F230	11/12	AF
CG-F240	13/14	AF
CG-F250	15/16	AF
CG-F260	1/2	MF
CG-F270	3/4	MF
CG-F280	5/6	MF
CG-F290	7/8	MF
CG-F310	11/12	MF
CG-F320	13/14	MF
CG-F330	15/16	MF



CG-F260 CG-F270 CG-F280 CG-F290 CG-F310 CG-F320 CG-F330

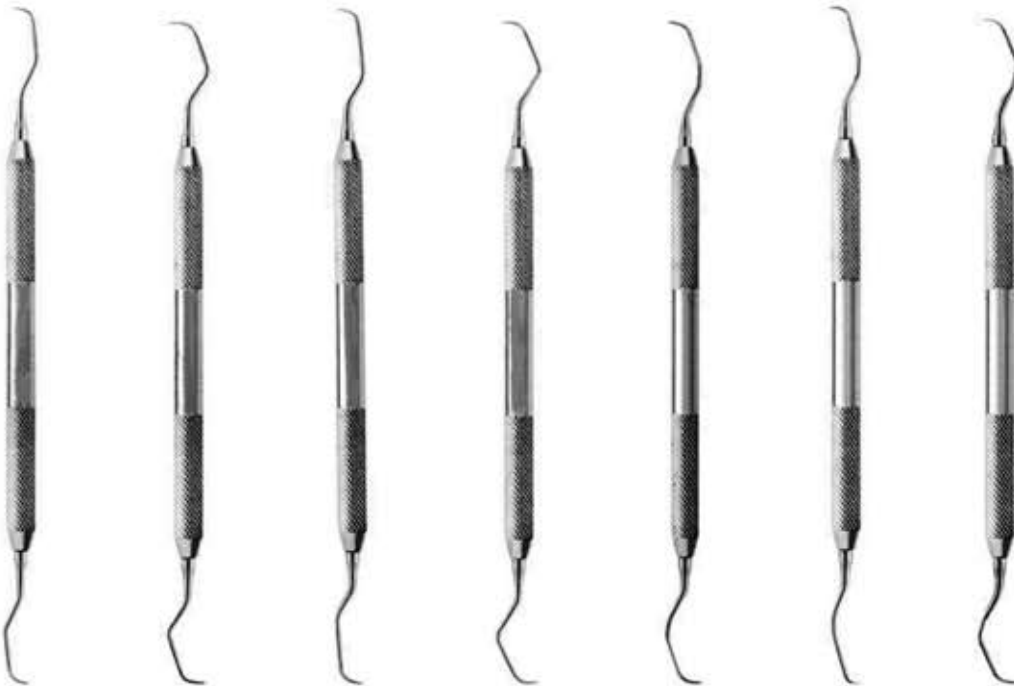

CG-F180 CG-F190 CG-F200 CG-F210 CG-F230 CG-F240 CG-F250

Hemingway Bone Curette

SKU	Fig
HEM-2501	1R/1L
HEM-2502	2R/2L
HEM-2503	3R/3L
HEM-2504	1/1
HEM-2505	2/2
HEM-2506	3/3

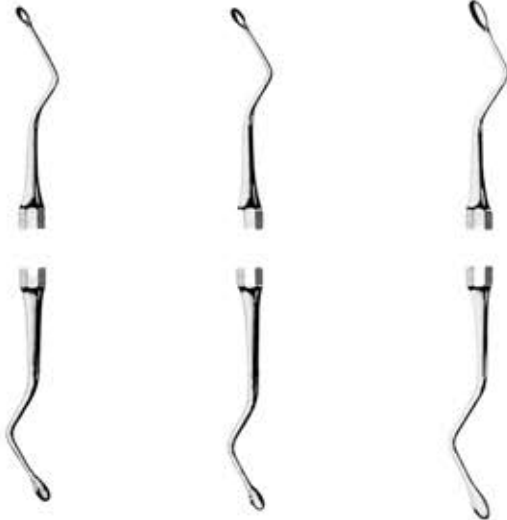

HEM-2501

HEM-2502

HEM-2503

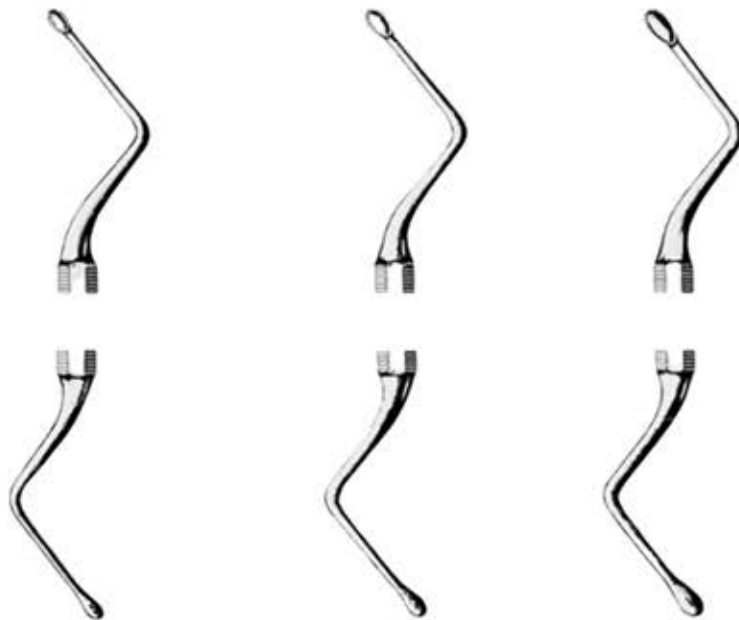

HEM-2504

HEM-2505

HEM-2506

**Hoexter Periodontal Curette**

SKU	Fig
AAA-2234A	1
AAA-2234B	2
AAA-2234C	3



AAA-2234A



AAA-2234B



AAA-2234C

**Jacquette Curette**

SKU	Fig
JC-F001	1
JC-F002	2
JC-F003	3



JC-F001



JC-F003



JC-F002

**Kirkland Periodontal Curette**

SKU	Fig
KIR-550S	8K/9K



KIR-550S

**Kramer Nevins Periodontal Curette**

SKU	Fig
AAA-2236A	3/4
AAA-2236B	4

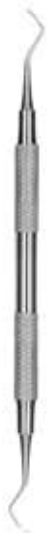

AAA-2236A



AAA-2236B

Langer Curette

SKU	Fig
CL-L17	1/2
CL-U17	3/4
CL-A175	5/6
CL-B175	17/18

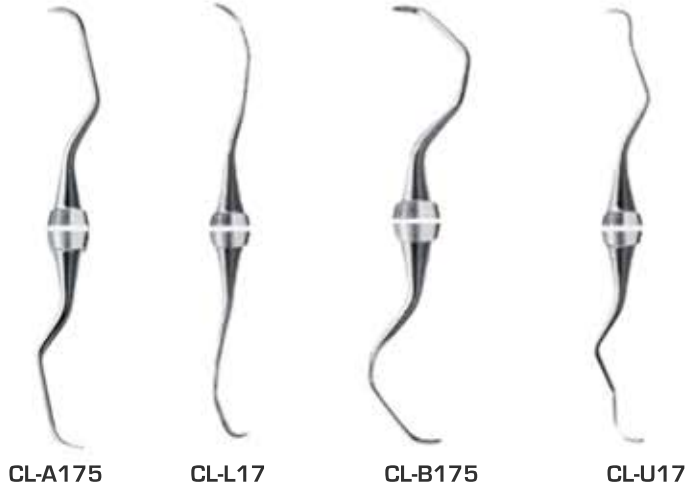

CL-A175

CL-L17

CL-B175

CL-U17

Lucas Dental Curette

SKU	Fig
LUC-2500A	1/1
LUC-2500B	2/2
LUC-2500C	3/3
LUC-2500E	4/4

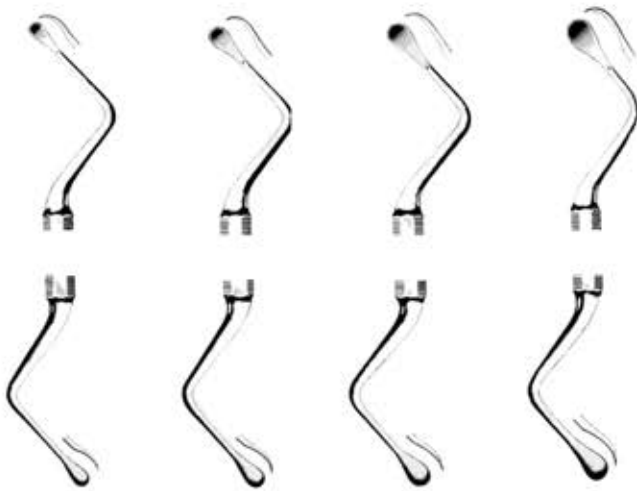

LUC-2500A

LUC-2500B

LUC-2500C

LUC-2500E

**Martini Bone Curette**

SKU	Fig
MAR-2100A	00/00
MAR-2100B	0/0
MAR-2100C	1/1



MAR-2100A

MAR-2100B

MAR-2100C

**Mead Bone Curette**

SKU	Fig
MB-004	4
MB-005	5



MB-004

MB-005

Miller Colburn Bone Curette

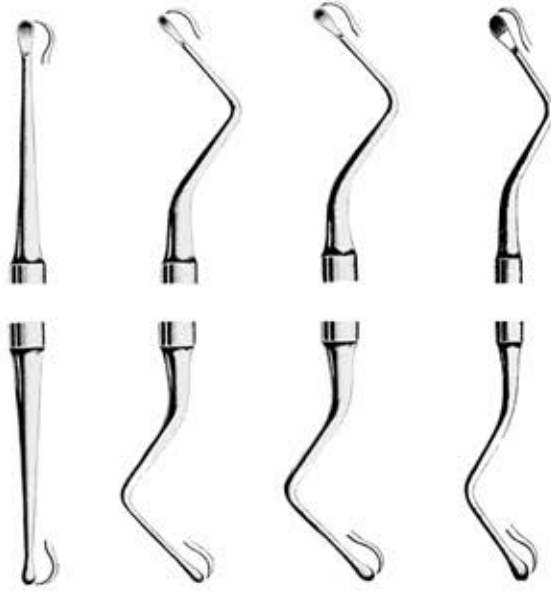

MIL-550A      MIL-550B      MIL-550C      MIL-550E

SKU	Fig
MIL-550A	1
MIL-550B	2
MIL-550C	3
MIL-550E	4

Molt Dental Curette



AAA-2240A

SKU	Fig
AAA-2240A	2/4

McCall Curette

SKU	Fig
MC-C134	13S/14S



MC-C134

Prichard Periodontal Curette

SKU	Fig
AAA-2237	PR1/2



AAA-2237



**Sugarman Periodontal Curette**

SKU	Fig
AAA-2238A	5S/6S
AAA-2238B	9S/10S
AAA-2238C	11S/12S



AAA-2238A



AAA-2238B



AAA-2238C

**Towner / Jacquette Curette**

SKU	Fig
TJ-1523	U15/23



TJ-1523

**USA Bone Curette**

SKU	Fig	Tip
USA-2100A	1	Straight
USA-2100B	2	Straight
USA-2100C	3	Straight
USA-2100G	4	Straight
USA-2100E	5	Straight
USA-2100F	6	Straight
USA-2200A	1	Right
USA-2200B	2	Right
USA-2200C	3	Right
USA-2200G	4	Right
USA-2200E	5	Right
USA-2200F	6	Right
USA-2300A	1	Left
USA-2300B	2	Left
USA-2300C	3	Left
USA-2300G	4	Left
USA-2300E	5	Left
USA-2300F	6	Left

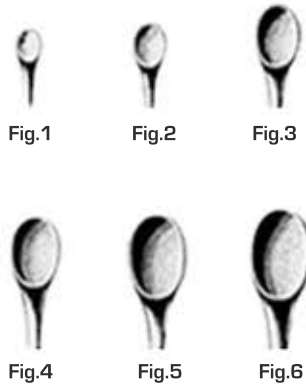
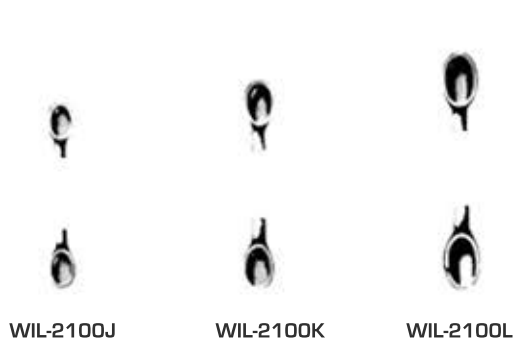

Fig.1	USA-2100A	USA-2300A	USA-2200A
Fig.2	USA-2100B	USA-2300B	USA-2200B
Fig.3	USA-2100C	USA-2300C	USA-2200C
Fig.4	USA-2100G	USA-2300G	USA-2200G
Fig.5	USA-2100E	USA-2300E	USA-2200E
Fig.6	USA-2100F	USA-2300F	USA-2200F

**Williger Bone Curette**



SKU	Fig	Tip	Type
WIL-2100A	00	Round	Straight
WIL-2100B	0	Round	Straight
WIL-2100C	1	Round	Straight
WIL-2100Z	2	Round	Straight
WIL-2100E	00	Oval	Straight
WIL-2100F	0	Oval	Straight
WIL-2100G	1	Oval	Straight
WIL-2100H	2	Oval	Straight
WIL-2100M	00	Round	Angular
WIL-2100N	0	Round	Angular
WIL-2100P	1	Round	Angular
WIL-2100Q	2	Round	Angular
WIL-2100R	00	Oval	Angular
WIL-2100S	0	Oval	Angular
WIL-2100T	1	Oval	Angular
WIL-2100U	2	Oval	Angular
WIL-2100J	00/00		
WIL-2100K	0/0		
WIL-2100L	1/1		

Towner Curette

SKU	Fig
TC-U15A	U15



TC-U15A

Younger-Good Curette

SKU	Fig
YG-100A	7/8



YG-100A

# PERIODONTAL KNIVES

**Buck Periodontal Knife**



AAA-A224



AAA-B224

SKU	Fig
AAA-A224	3/4
AAA-B224	5/6

**Crane-Kaplan Periodontal Knife**



AAA-2225

SKU	Fig
AAA-2225	CK-3

**Goldman-Fox Periodontal Knife**

SKU	Fig
AAA-2297	7
AAA-2297A	8
AAA-2297B	9
AAA-2297C	10
AAA-2298A	11
AAA-2298B	21

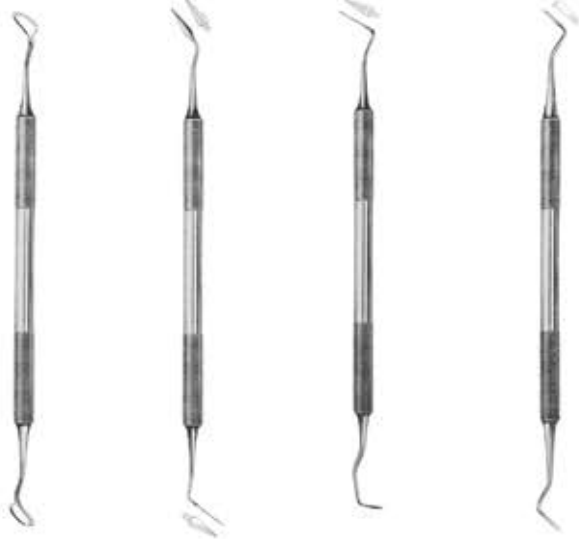

AAA-2297      AAA-2297A      AAA-2297B      AAA-2297C



AAA-2298A      AAA-2298B

**Kirkland Periodontal Knife**

SKU	Fig
KK-L17A	15
KK-L17B	16
KK-L17C	15/16



KK-L17A      KK-L17B      KK-L17C

**Kramer-Nevins Periodontal Knife**

SKU	Fig
AAA-2227	7
AAA-2227A	11



AAA-2227



AAA-2227A

**Orban Periodontal Knife**

SKU	Shape
RBG-101	Double Ended
RBG-102	Single Ended



RBG-101



RBG-102



**Orban Periodontal Knife**

SKU	Fig
RBG-103	1
RBG-104	2
RBG-105	21
RBG-106	22
RBG-100	1/2



RBG-105



RBG-106



RBG-100



RBG-103

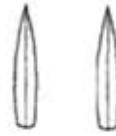

RBG-104

**Reddy Thin Periodontal Knife**

SKU	Fig
AAA-2230A	1
AAA-2230B	2



AAA-2230A



AAA-2230B

# SCALERS

**Abott Scaler**

SKU	Fig
ABT-990	1
ABT-991	2
ABT-992	3
ABT-993	4

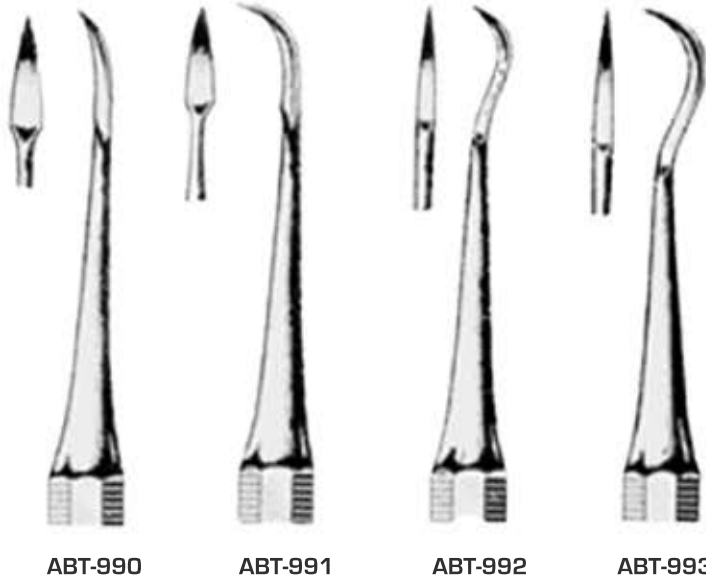

**Baylor Scaler**

SKU
BAY-0202
BAY-0203

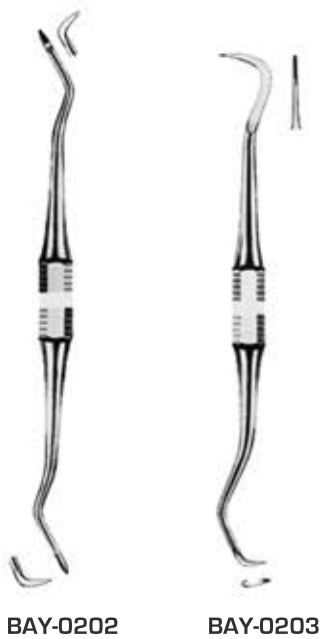

**Black Scaler**

SKU	Fig
SCA-1110	
BLK-0011	1
BLK-0012	2
BLK-0013	3
BLK-0014	4
BLK-0015	5
BLK-0016	6
BLK-0017	7
BLK-0018	8
BLK-0019	9
BLK-0020	10
BLK-0021	11
BLK-0022	12

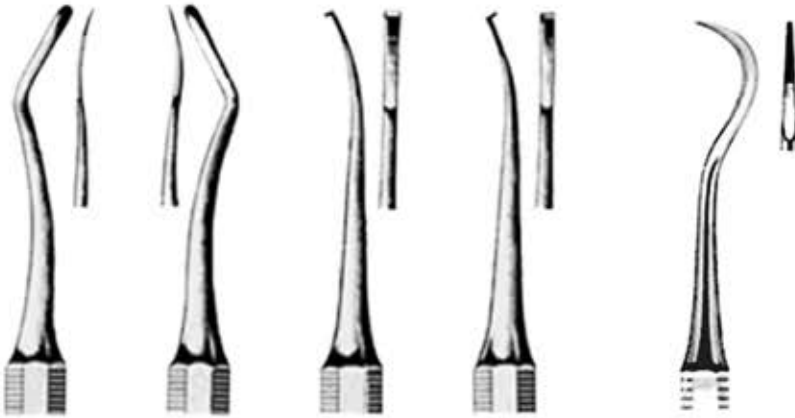

BLK-0011    BLK-0012    BLK-0013    BLK-0014    SCA-1110



BLK-0015    BLK-0016    BLK-0017    BLK-0018    BLK-0019    BLK-0020    BLK-0021    BLK-0022

**California Scaler**

SKU	Handle
SCA-020A	Octagonal



SCA-020A

**Cleveland Scaler**

SKU
CCA-001



CCA-001

**Columbia Scaler**



SKU	Fig
COL-013A	13/14
COL-013B	2R/2L
COL-013C	4R/4L

**Crane Kaplan Scaler**



SKU	Fig
CCS-060K	CK6D
CCS-006K	CK6
CKS-0106	CK-6

**Cumine Scaler**

SKU
CUM-011



CUM-011

**Cushing Scaler**

SKU
SCA-1111



SCA-1111

**Darby-Perry Scaler**

SKU	Fig
SDA-001	1
SDA-004	4
SDA-005	5
SDA-006	6
SDA-0011	11



SDA-001    SDA-004    SDA-005    SDA-006    SDA-0011

**Fehr Scaler**



SKU	Fig	Style
SCA-1112		
FEH-213A	213	Double Ended

**Globe Scaler**



GLB-011

SKU
GLB-011

**Goldman-Fox Scaler**



GFS-011A GFS-011B GFS-011C GFS-011D GFS-011E GFS-011F

SKU	Fig
GFS-011A	1
GFS-011B	2
GFS-011C	3
GFS-011D	4
GFS-011E	5
GFS-011F	6



**Guy Scaler**

SKU	Fig
GUY-991	1
GUY-992	2
GUY-993	3
GUY-994	4

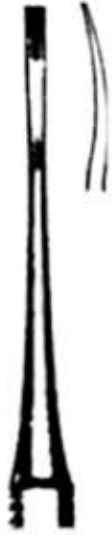

GUY-991



GUY-992



GUY-993



GUY-994

**Guenther Scaler**

SKU
GUN-011



GUN-011

**Haubeil Scaler**

SKU	Fig
HAU-222	Double Ended



HAU-222

**Hygienist Scaler**

SKU	Fig
HYG-111A	H4
HYG-111B	H5
HYG-111C	H6
HYG-111D	H7
HYG-111E	H8
HYG-111F	H9
HYG-111G	H5/33
HYG-111H	H6/H7



HYG-111H

HYG-111G



HYG-111A

HYG-111B

HYG-111C

HYG-111D

HYG-111E

HYG-111F

Jacquette Scaler

SKU	Fig
JAC-011J	J1
JAC-012J	J2
JAC-013J	J3
JAC-014J	261
JAC-015J	262
JAC-016J	14/15
JAC-017J	30/31
JAC-018J	31/32
JAC-019J	34/35
JAC-020J	37/38
JAC-021J	H3/H4



JAC-011J



JAC-012J



JAC-013J



JAC-014J



JAC-015J

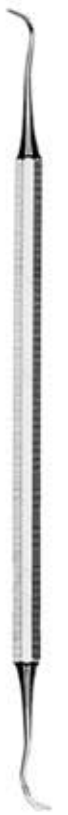

JAC-016J

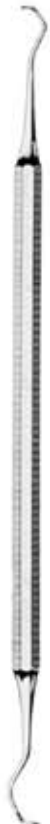

JAC-017J

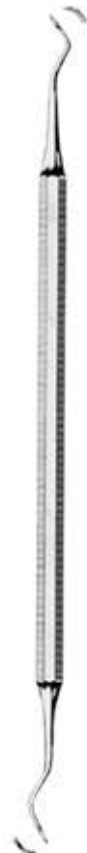

JAC-018J



JAC-019J



JAC-020J

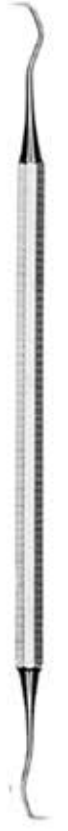

JAC-021J

**Langer Scaler**



SKU	Fig
LAN-012A	1/2
LAN-034A	3/4
LAN-056A	5/6

**Mitchell Scaler**



MIT-011

SKU	Style
MIT-011	Double Ended

**McCall Scaler**

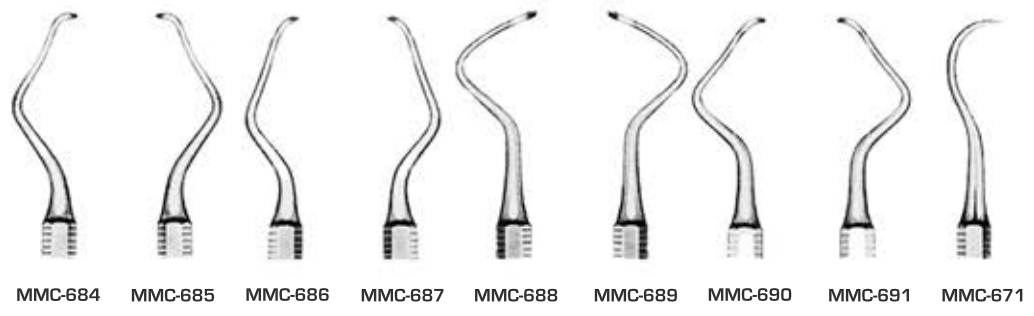
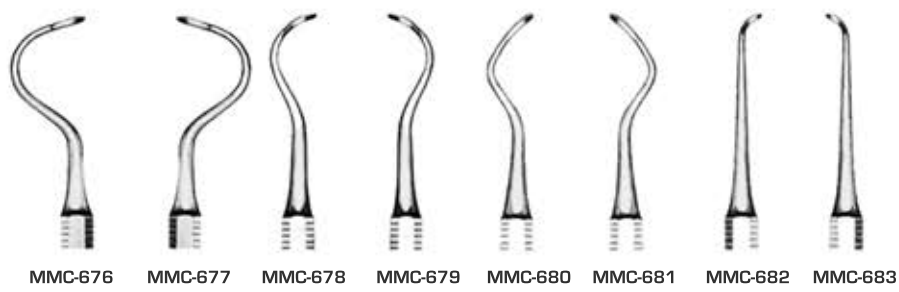
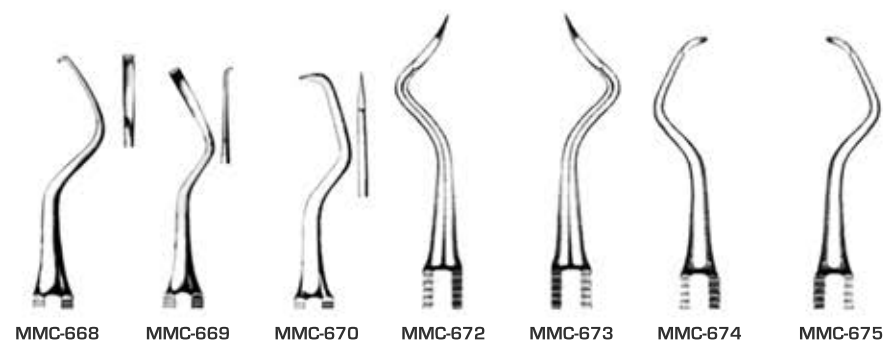
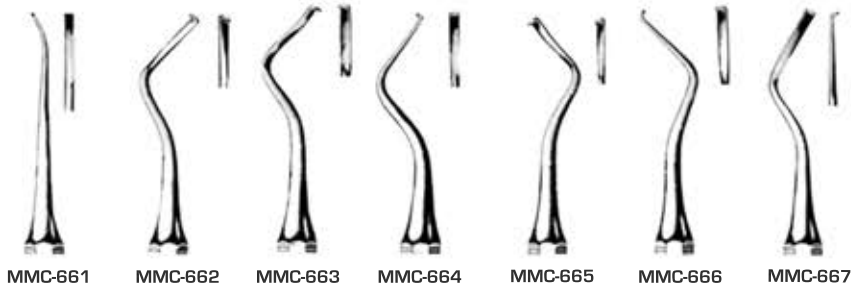

SKU	Fig
MMC-661	1
MMC-662	2
MMC-663	3
MMC-664	4
MMC-665	5
MMC-666	6
MMC-667	7
MMC-668	8
MMC-669	9
MMC-670	10
MMC-671	10A
MMC-672	11A
MMC-673	12A
MMC-674	13
MMC-675	14
MMC-676	15
MMC-677	16
MMC-678	17
MMC-679	18
MMC-680	19
MMC-681	20
MMC-682	21
MMC-683	22
MMC-684	23
MMC-685	24
MMC-686	25
MMC-687	26
MMC-688	27
MMC-689	28
MMC-690	29
MMC-691	30
MMC-692	13/14
MMC-693	13S/14S

**Moore Scaler**

SKU	Fig
MRE-111	1
MRE-112	2



MRE-111



MRE-112

**Muehleemann Scaler**

SKU	Fig	Style
SCA-1113		
SCA-1114	2R	
SCA-1115	2L	
SCA-1118		Double Ended



SCA-1113



SCA-1115



SCA-1114



SCA-1118

**Remington Scaler**



SCA-1119

SKU	Style
SCA-1119	Double Ended

**Scaler Double Ended**



SCD-034B



SCD-034A



SCD-204S



SCD-034E



SCD-034F



SCD-034C



SCD-034D

SKU	Fig
SCD-034A	33/34
SCD-034B	SCI 2/3
SCD-034C	229
SCD-034D	230
SCD-034E	232
SCD-034F	233
SCD-204S	204S

Scaler Single Ended

SKU	Fig	Handle
SCA-001A	2L	Octagonal
SCA-001B	2R	Octagonal
SCA-001C	4L	Octagonal
SCA-001D	4R	Octagonal
SCA-001E	33 1/2	Octagonal
SCA-001F	33A	Octagonal
SCA-001G	34 1/2	Octagonal
SCA-001H	34A	Octagonal
SCA-001J	32	Octagonal
SCA-001K	33	Octagonal
SCA-001L	34	Octagonal

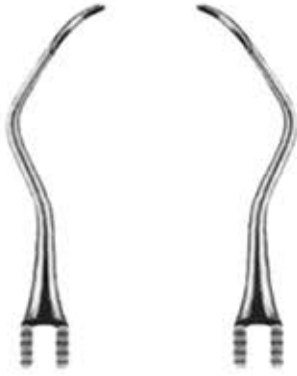

SCA-001A

SCA-001B



SCA-001C

SCA-001D



SCA-001L



SCA-001E



SCA-001G



SCA-001F



SCA-001H



SCA-001J



SCA-001K



**Scaler Single Ended Series 1**

SKU	Tip	Handle
SSA-0101	1	Octagonal
SSA-0102	2	Octagonal
SSA-0103	3	Octagonal
SSA-0104	4	Octagonal
SSA-0105	5	Octagonal
SSA-0106	6	Octagonal



SSA-0101



SSA-0102



SSA-0103



SSA-0104



SSA-0105



SSA-0106

**Scaler Single Ended Series 2**

SKU	Fig	Handle
SSA-0201	1	Octagonal
SSA-0202	2	Octagonal
SSA-0203	3	Octagonal
SSA-0204	4	Octagonal
SSA-0205	5	Octagonal
SSA-0206	6	Octagonal
SSA-0207	7	Octagonal
SSA-0208	8	Octagonal



SSA-0201



SSA-0202



SSA-0203



SSA-0204



SSA-0205



SSA-0206



SSA-0207



SSA-0208

**Scaler USC**

SKU	Fig
SCD-1208U	128



SCD-1208U

**Scharmann Scaler**

SKU	Fig
SCH-4001	1
SCH-4002	2
SCH-4003	3
SCH-4004	4
SCH-4005	5
SCH-4006	6
SCH-4007	7
SCH-4008	8



SCH-4001



SCH-4002



SCH-4003



SCH-4004



SCH-4005



SCH-4006



SCH-4007



SCH-4008

**Senns Scaler**

SKU	Style
SCA-1116	Single Ended



SCA-1116

**Shepherd Scaler**

SKU	Style
SHP-011	Double Ended



SHP-011

**Sichel 23 Scaler**

SKU	Handle
SCA-1120	Octagonal



SCA-1120

**Smith Scaler**

SKU	Handle
SCA-1121	Octagonal



SCA-1121

**Taylor Scaler**



TAY-23ST

SKU	Fig
TAY-23ST	ST 2/3

**Thorpe I Scaler**



SCA-1122

SKU	Handle
SCA-1122	Octagonal

**Thorpe II Scaler**



SCA-1123

SKU	Handle
SCA-1123	Octagonal

**Tompkins Scaler**

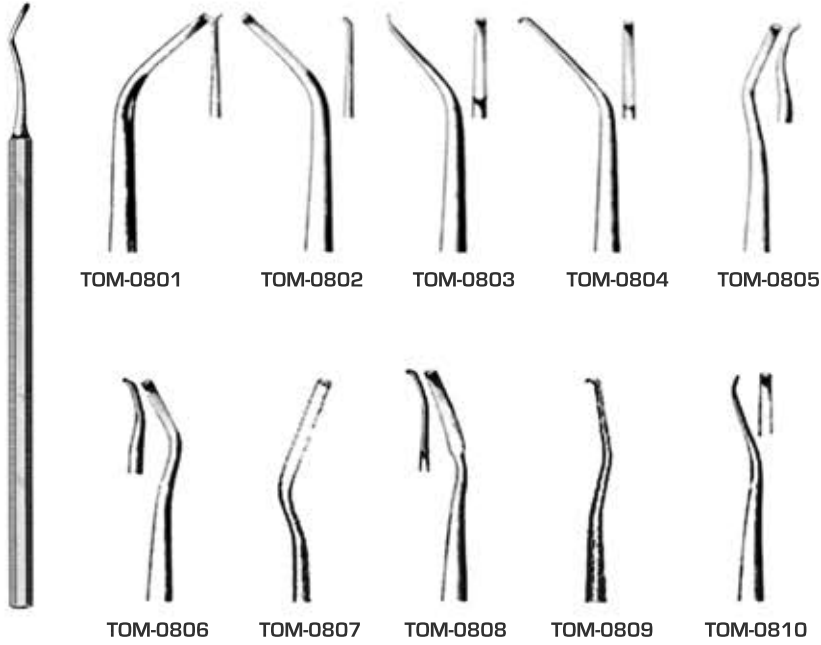

SKU	Fig	Handle
TOM-0801	1	Octagonal
TOM-0802	2	Octagonal
TOM-0803	3	Octagonal
TOM-0804	4	Octagonal
TOM-0805	5	Octagonal
TOM-0806	6	Octagonal
TOM-0807	7	Octagonal
TOM-0808	8	Octagonal
TOM-0809	11	Octagonal
TOM-0810	12	Octagonal

**Towner Jacquette Scaler**



SKU	Fig
SCA-1124	U15/30
SCA-1125	U15/33

White Scaler

SKU	Fig
WHT-111	1
WHT-112	2
WHT-113	3
WHT-112B	12B



WHT-111



WHT-112



WHT-113



WHT-112B

Whiteside Scaler

SKU	Fig	Handle
WHT-0123	1	Octagonal
WHT-0124	2	Octagonal
WHT-115A	2	



WHT-115A



WHT-0123



WHT-0124

**Whitten Scaler**



WHT-114

SKU	Fig	Handle
WHT-114	1	Octagonal

**Williger Scaler**



SCA-1117

SKU
SCA-1117

**Younger 15 Scaler**



YOG-080

SKU	Handle
YOG-080	Octagonal



**Younger Good Scaler**

SKU	Fig	Style
YOG-078	7/8	Double Ended
YOG-079		Double Ended
YOG-081	13	
YOG-082	14	
YOG-083	15	



**Zerfing Scaler**

SKU
ZER-555



# CARVERS

**Andrew Carver**

SKU	Fig
ANC-001	1
ANC-002	2
ANC-003	3



ANC-001



ANC-002



ANC-003

**Clappison Carver**

SKU	Fig
CCC-02	2
CCC-04	4



CCC-02



CCC-04

**Cleoid Discoid Carver**

SKU	Fig
CDC-C36	3/6
CDC-C45	4/5
CDC-C82	89/92
CDC-C90B	90B
CDC-C110	110
CDC-C12	1/2
CDC-C1WA	WACD

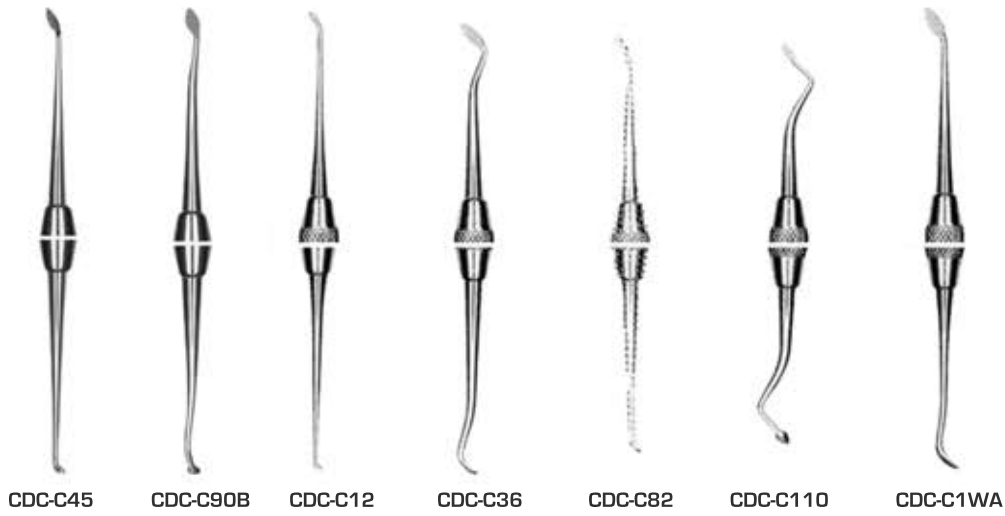

**Cleoid Discoid Carver Vignon**

SKU
CDC-02V



**Frahm Carver**



ABB-0101A

SKU	Fig
ABB-0101A	2/3

**Hollenback Carver**



ABB-093A

ABB-098A

ABB-085A

SKU	Fig
ABB-093A	3S
ABB-098A	3
ABB-085A	1/2

**Hollenback Cleoid**

SKU	Fig
HLC-01C	1
HLC-02C	2
HLC-03C	3



HLC-01C

HLC-02C

HLC-03C

**Interproximal Carver**

SKU	Fig
IPC-01C	1
IPC-02C	2



IPC-01C

IPC-02C

**Lecron Carver**

SKU	Fig
ABB-0600A	6
ABB-0100A	5



ABB-0600A



ABB-0100A

**Sprengel Carver**

SKU	Fig
SPG-18C	18



SPG-18C

**Tanner Carver**

SKU	Fig
ABB-0103A	3
ABB-0104A	4
ABB-0105A	5
ABB-0106A	6



ABB-0103A      ABB-0104A      ABB-0105A      ABB-0106A

**Tharp Carver**

SKU	Fig
THC-01C	1
THC-02C	2
THC-03C	3
THC-OAC	A
THC-07LC	L7

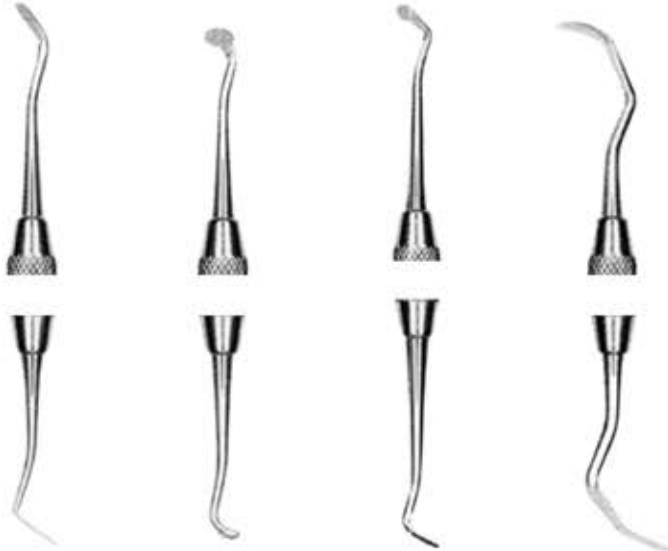

THC-01C      THC-02C      THC-03C      THC-OAC      THC-07LC



**Vehe Carver**



VCS-01C

SKU	Shape
VCS-01C	Spade Shape, Small Spade Scoop Shape

**Ward Carver**



ABB-0113A



ABB-0112A

SKU	Fig
ABB-0112A	1
ABB-0113A	2

**Wiland Carver**



WIC-08C



WIC-01C

SKU	Fig
WIC-08C	8
WIC-01C	IPC-1

# BONE FILES

**Sugarman Periodontal File**

SKU	Fig
AAA-2164A	1S/2S
AAA-2164B	3S/4S



AAA-2164A

AAA-2164B

**Wahl Bone File**

SKU	Fig
AAA-2241A	1W
AAA-2241B	2W



AAA-2241A

AAA-2241B

**Buck Periodontal File**

SKU	Fig
AAA-2243A	11/12



AAA-2243A

**Schluger Periodontal File**

SKU	Fig
AAA-2245A	9/10



AAA-2245A

**Hirschfeld Periodontal File**

SKU	Fig
HIR-037F	3/7
HIR-511F	5/11
HIR-910F	9/10

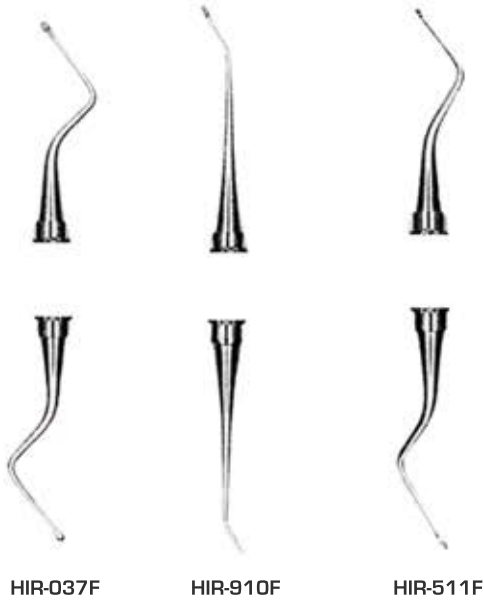

**Miller-Colburn Bone File**

SKU	Fig	Shape
MBF-X01A	1	Cross-Cut
MBF-X01B	1	Straight Cut
MBF-X02A	2	Cross-Cut
MBF-X02B	2	Straight Cut
MBF-X03A	3	Cross-Cut
MBF-X03B	3	Straight Cut
MBF-X04A	4	Cross-Cut
MBF-X04B	4	Straight Cut
MBF-X05A	5	Cross-Cut
MBF-X05B	5	Straight Cut

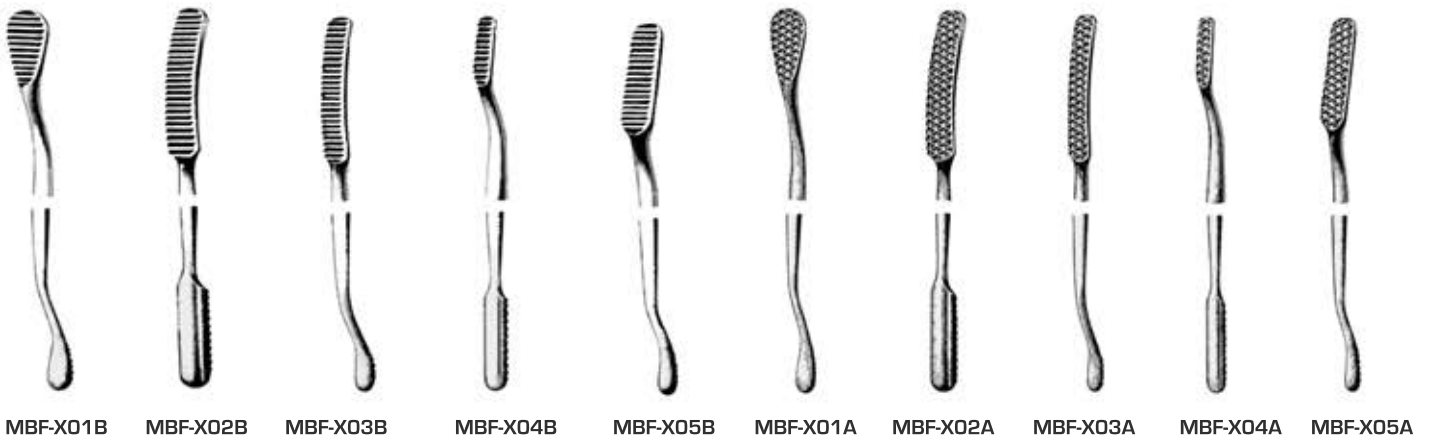

# PLUGGERS

**Amalgam Plugger**

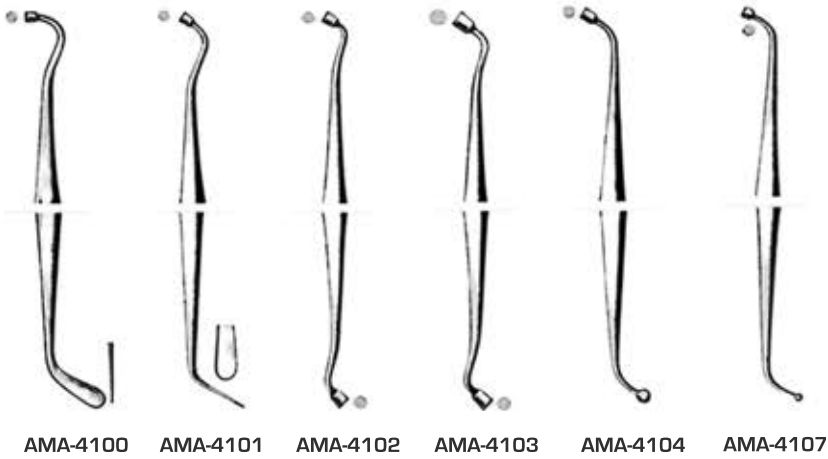

SKU	Fig
AMA-4100	1
AMA-4101	2
AMA-4102	3
AMA-4103	4
AMA-4104	5
AMA-4105	6
AMA-4106	7
AMA-4107	5A

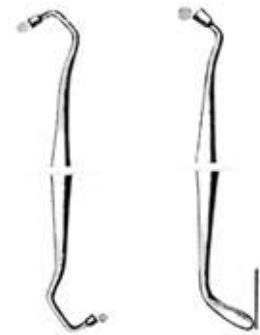

AMA-4105      AMA-4106

**Haubeil Amalgam Plugger**

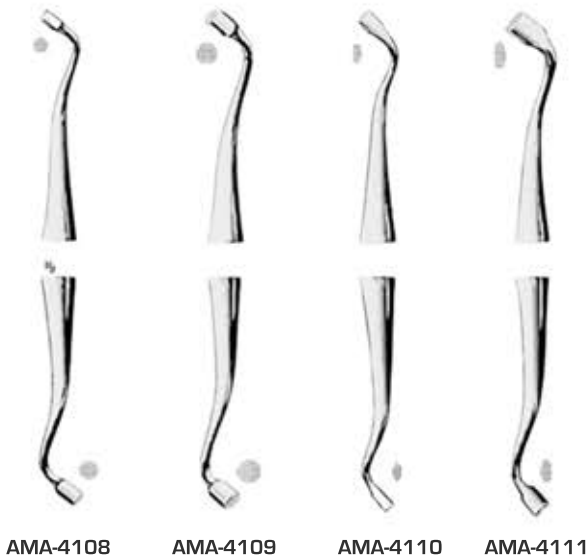

SKU	Fig
AMA-4108	1/2
AMA-4109	3/4
AMA-4110	5/6
AMA-4111	7/8

**Hollenback Amalgam Plugger**

SKU	Fig
AMA-4112	1
AMA-4113	2
AMA-4114	3
AMA-4115	4
AMA-4116	5
AMA-4117	6
AMA-4118	7



AMA-4112    AMA-4113    AMA-4114    AMA-4115    AMA-4116    AMA-4117    AMA-4118

**Luks Plugger**

SKU	Fig	Tip Size
LUK-0123	1	0.45mm
LUK-0124	2	0.50mm
LUK-0125	3	0.75mm
LUK-0126	4	1.0mm

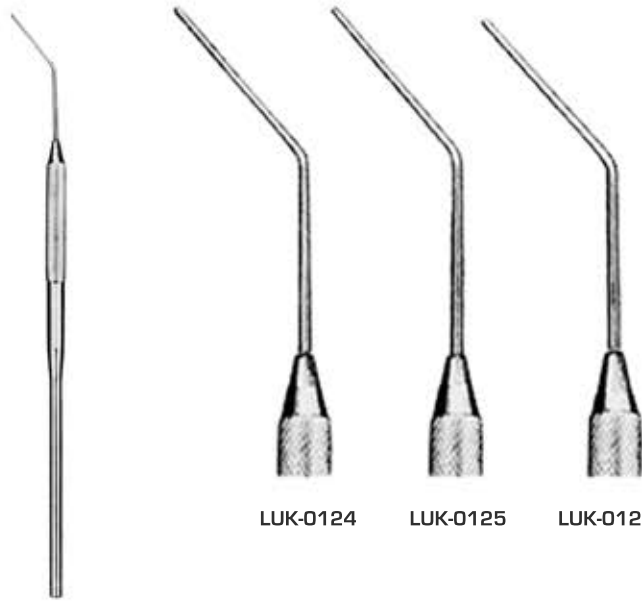

LUK-0123

LUK-0124

LUK-0125

LUK-0126



## Machtou Root Canal Plugger

SKU	Fig	Tip Size
MAC-401	1	0.4mm/0.4mm
MAC-402	2	0.4mm/0.4mm
MAC-403	3	0.6mm/0.1mm
MAC-404	4	0.6mm/0.1mm

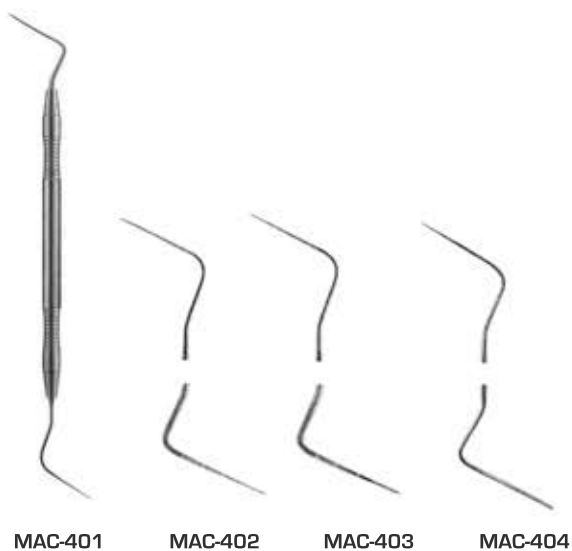

## Root Canal Plugger

SKU	Fig	Tip Size
RTP-0128	8	0.40mm
RTP-0129	9	0.55mm
RTP-0130	10	0.75mm
RTP-0131	11	1.05mm
RTP-0132	12	1.30mm
RTP-0133	1/2	0.40mm/0.45mm
RTP-0134	5/7	0.50mm/0.75mm
RTP-0135	9/11	1.0mm/1.15mm

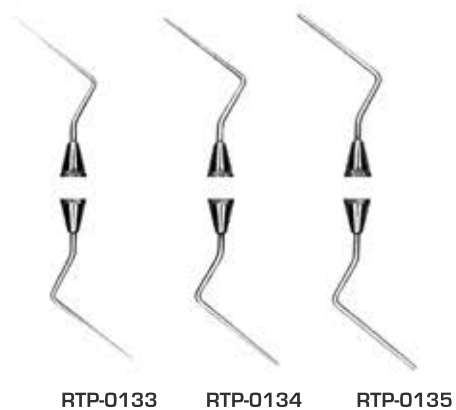
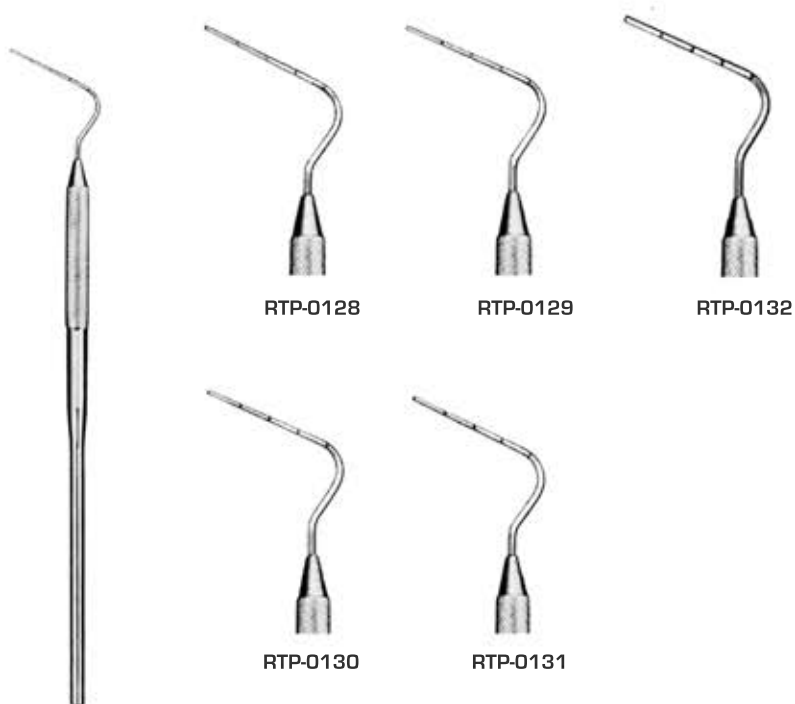

**Schilder Plugger**



SCP-0125



SCP-0126



SCP-0117

SKU	Fig	Tip Size
SCP-0117	7	0.30mm
SCP-0118	7 1/2	0.35mm
SCP-0119	8	0.40mm
SCP-0120	8 1/2	0.50mm
SCP-0121	9	0.60mm
SCP-0122	9 1/2	0.70mm
SCP-0123	10	0.80mm
SCP-0124	10 1/2	0.90mm
SCP-0125	11	1.05mm
SCP-0126	11 1/2	1.20mm



SCP-0118



SCP-0119



SCP-0120



SCP-0121



SCP-0122



SCP-0123



SCP-0124

**Thuerriegel Root Canal Plugger**

SKU
THU-0100



THU-0100

**Vertical Condenser**

SKU	Fig	Tip Size
VER-0100A	1	0.5mm
VER-0100B	2	0.7mm
VER-0100C	3	0.9mm
VER-0100E	4	1.1mm

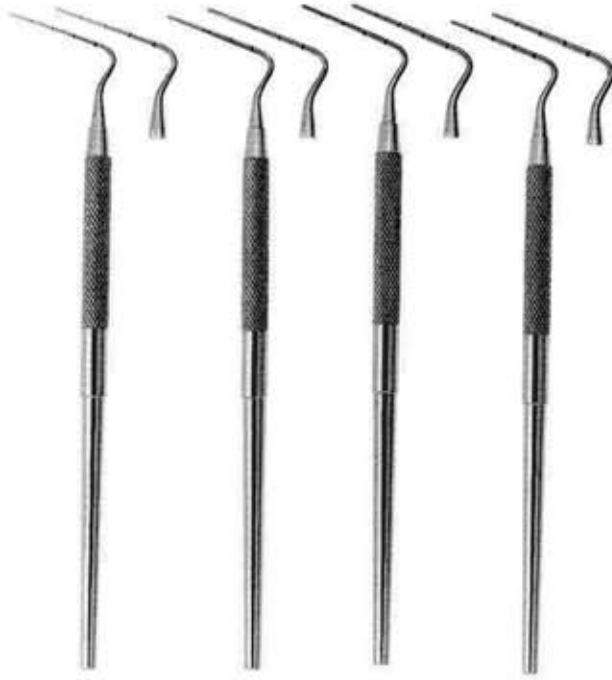

VER-0100A

VER-0100B

VER-0100C

VER-0100E

# FINISHING FILES

**Black Finishing File**

SKU	Fig
BFF-0145	1
BFF-0146	2
BFF-0147	3
BFF-0148	4
BFF-0149	5
BFF-0150	6



BFF-0145



BFF-0146



BFF-0147



BFF-0148



BFF-0149



BFF-0150

**Rhein Finishing File**

SKU	Fig
RHN-0031	31
RHN-0032	32



RHN-0031



RHN-0032

**Tompkins Finishing File**

SKU	Fig
TOM-8001	1
TOM-8002	2
TOM-8003	3
TOM-8004	4



TOM-8001



TOM-8002



TOM-8003



TOM-8004

**Wedelstaedt Finishing File**

SKU	Fig
WED-0001	1
WED-0002	2
WED-0003	3
WED-0004	4
WED-0005	5
WED-0006	6



WED-0001



WED-0002



WED-0003



WED-0004



WED-0005



WED-0006

# EXCAVATORS

**Ash Excavator**



SKU	Fig
WHE-129	243
WHE-130	G2

**Darby Perry Excavator**

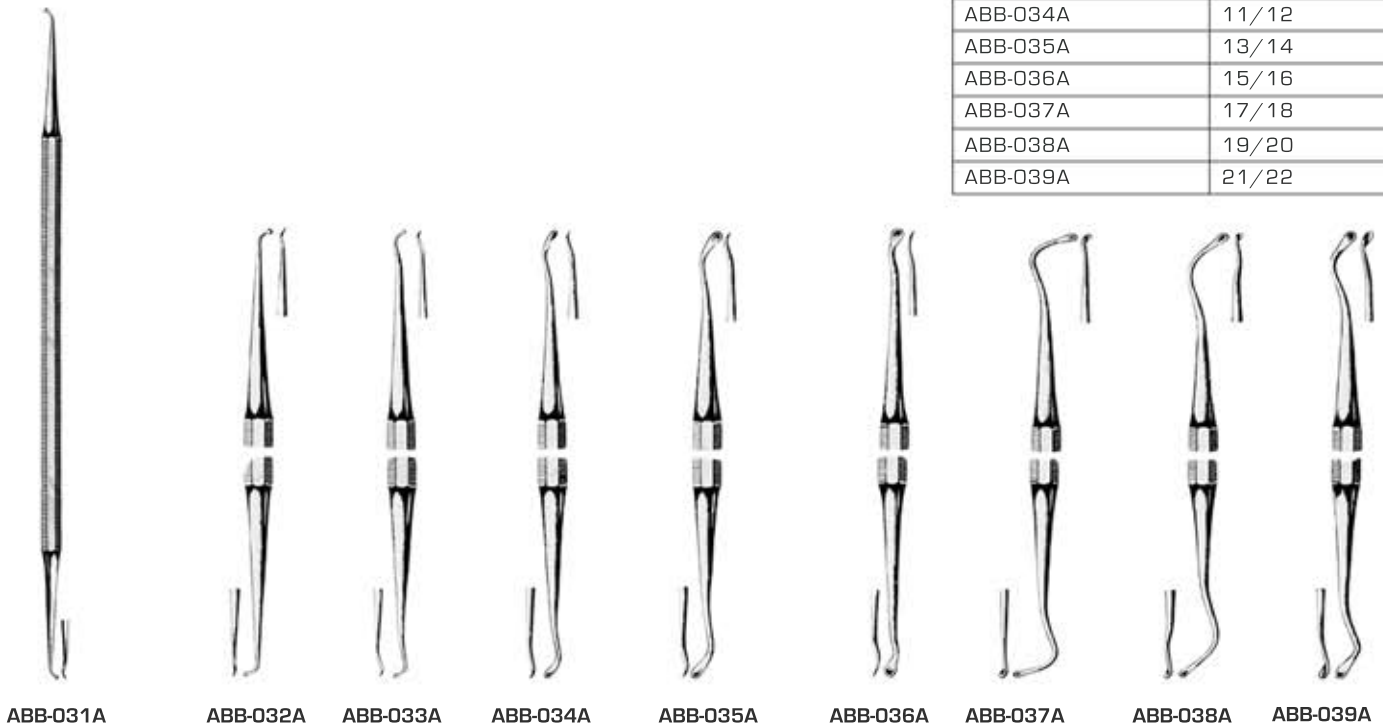

SKU	Fig
ABB-031A	5/6
ABB-032A	7/8
ABB-033A	9/10
ABB-034A	11/12
ABB-035A	13/14
ABB-036A	15/16
ABB-037A	17/18
ABB-038A	19/20
ABB-039A	21/22



**Dental Excavator**



ABB-040A ABB-041A ABB-042A ABB-043A ABB-046A ABB-047A ABB-050A ABB-051A



ABB-052A ABB-053A ABB-054A ABB-055A ABB-056A ABB-031B ABB-032B ABB-041B

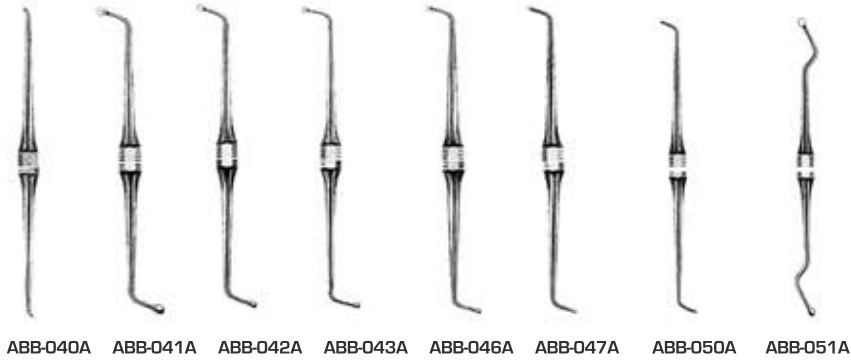

ABB-033B ABB-034B ABB-035B ABB-036B ABB-037B ABB-038B ABB-039B ABB-040B



ABB-043B ABB-050B ABB-051B ABB-046B ABB-047B ABB-052B ABB-053B ABB-042B

SKU	Fig
ABB-040A	111/112
ABB-041A	113/114
ABB-042A	115/116
ABB-043A	117/118
ABB-046A	119/120
ABB-047A	121/122
ABB-050A	123/124
ABB-051A	125/126
ABB-052A	127/128
ABB-053A	129/130
ABB-054A	131/132
ABB-055A	133/134
ABB-056A	155/156
ABB-031B	73/74
ABB-032B	74/111
ABB-033B	139/140
ABB-034B	141/142
ABB-035B	159/160
ABB-036B	161/162
ABB-037B	165/166
ABB-038B	171/172
ABB-039B	173/174
ABB-040B	175/176
ABB-041B	177/178
ABB-042B	179/180
ABB-043B	13
ABB-046B	14
ABB-047B	17
ABB-050B	18
ABB-051B	31
ABB-052B	33
ABB-053B	35

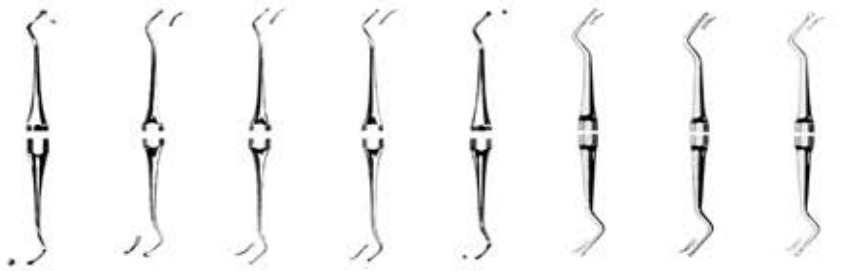
**Dental Excavator**

SKU	Fig	Tip Size
ABB-054B	1	0.8mm
ABB-055B	2	0.8mm
ABB-056B	11	1.0mm
ABB-031C	12	1.0mm
ABB-032C	21	1.2mm
ABB-033C	32	1.6mm
ABB-034C	41	2.0mm
ABB-035C	42	2.0mm
ABB-036C	22	1.2mm

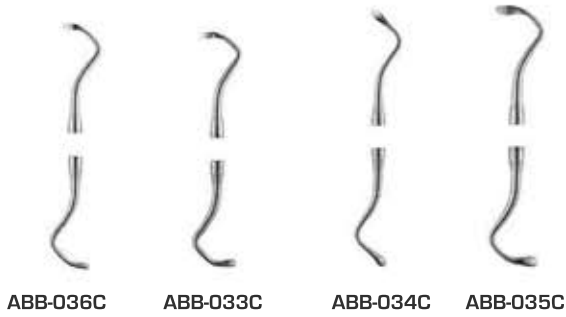
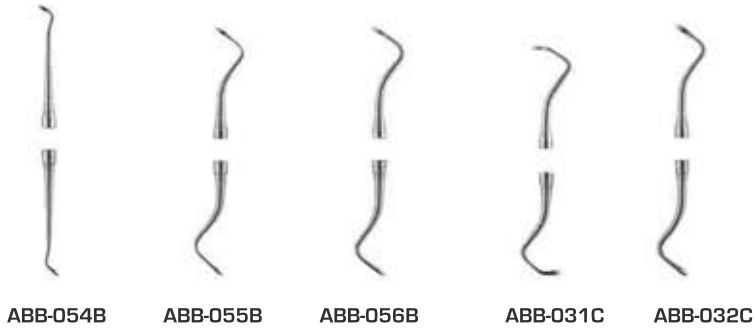

**White Excavator**

SKU	Fig
WHE-123	5
WHE-124	14
WHE-125	17
WHE-126	18
WHE-127	19
WHE-128	20

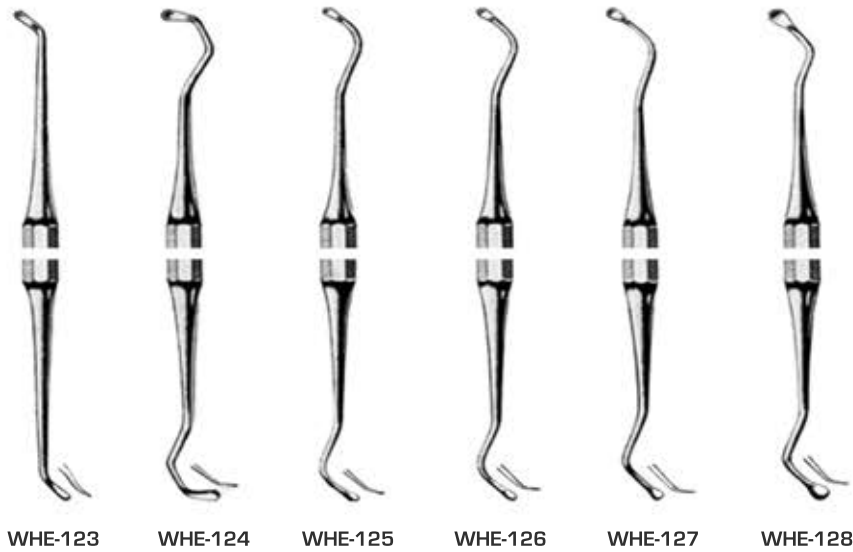

# CHISELS & OSTEOTOMES

**Buckley Bone Chisel**

SKU	Fig
BUC-1103	3



BUC-1103

**Chandler Bone Chisel**

SKU	Fig
AAA-2168A	1
AAA-2168B	2
AAA-2168E	3
AAA-2168F	4
AAA-2168G	5
AAA-2168H	6
AAA-2168J	7
AAA-2168K	8
AAA-2168L	9
AAA-2168C	13
AAA-2168D	15



AAA-2168D AAA-2168C

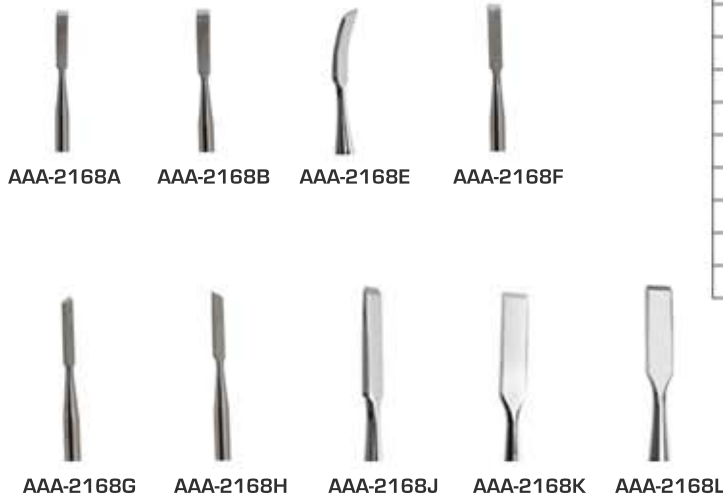

**Fedi Periodontal Chisel**

SKU	Fig
CF-001A	1
CF-002A	2
CF-003A	3
CF-004A	4



CF-001A



CF-002A



CF-003A



CF-004A

**Freer Chisel**

SKU	Length	Shape
FC-102	16cm	Curved
FC-101	16cm	Straight



FC-101



FC-102

**Gardner Bone Chisel**

SKU	Fig
GAR-1101	1
GAR-1102	2
GAR-1103	5
GAR-1104	5R
GAR-1105	6



GAR-1101      GAR-1102      GAR-1103      GAR-1104      GAR-1105

**Jovanovic Periodontal Chisel**

SKU	Fig
AAA-2169A	84



AAA-2169A

**Kirkland Periodontal Chisel**

SKU	Fig
KC-046A	13K/13KL
KC-034A	13K/TG



KC-046A



KC-034A

**Lucas Chisel**

SKU	Length	Blade
LC-016A	16cm	3mm



LC-016A

**Ochsenbein Periodontal Chisel**

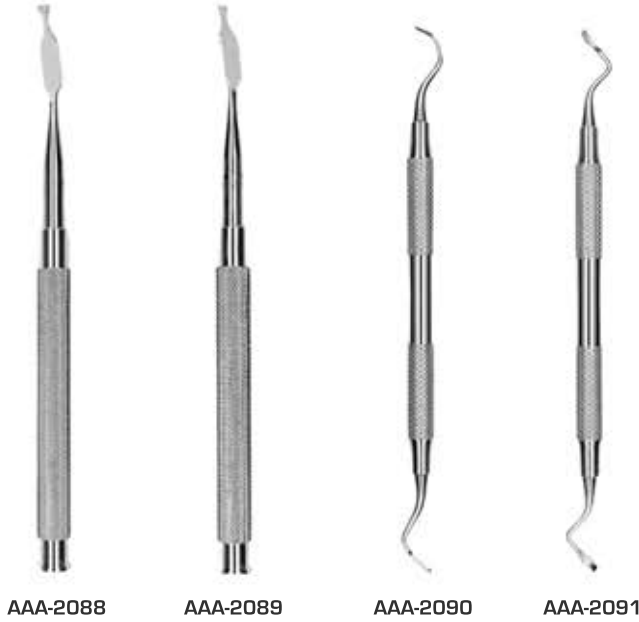

SKU	Fig
AAA-2088	1
AAA-2089	2
AAA-2090	3
AAA-2091	4

**Partsch Bone Chisel**

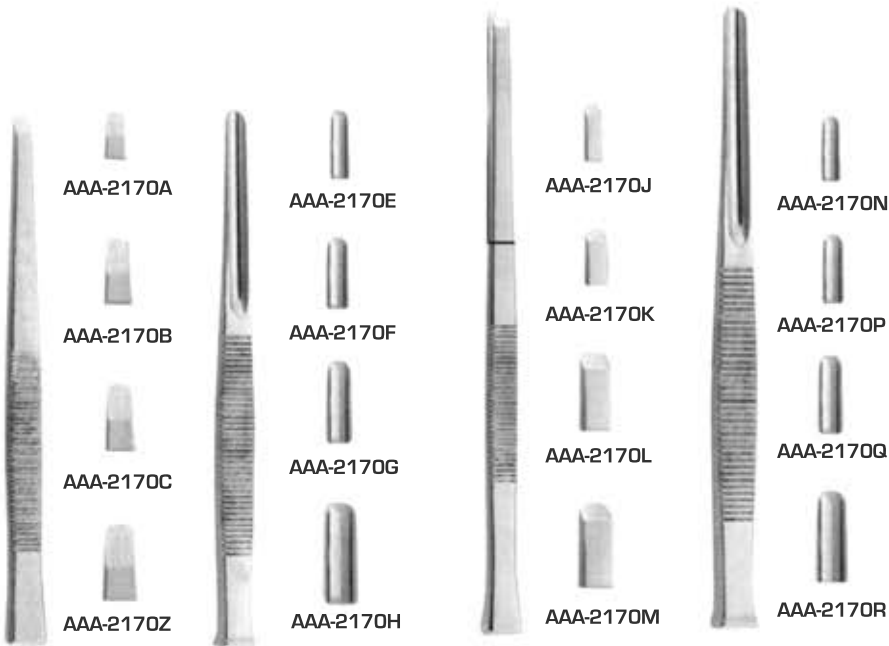

SKU	Length	Tip	Shape
AAA-2170A	13.5cm	3mm	Flat
AAA-2170B	13.5cm	4mm	Flat
AAA-2170C	13.5cm	5mm	Flat
AAA-2170Z	13.5cm	6mm	Flat
AAA-2170E	13.5cm	3mm	Grooved
AAA-2170F	13.5cm	4mm	Grooved
AAA-2170G	13.5cm	5mm	Grooved
AAA-2170H	13.5cm	6mm	Grooved
AAA-2170J	17cm	3mm	Flat
AAA-2170K	17cm	4mm	Flat
AAA-2170L	17cm	5mm	Flat
AAA-2170M	17cm	6mm	Flat
AAA-2170N	17cm	3mm	Grooved
AAA-2170P	17cm	4mm	Grooved
AAA-2170Q	17cm	5mm	Grooved
AAA-2170R	17cm	6mm	Grooved



**Rhodes Dental Chisel**



RC-L175

SKU	Fig
RC-L175	36/37

**Ridge Split Chisel**



AAA-2171A   AAA-2171B   AAA-2171C   AAA-2171D   AAA-2171E   AAA-2171F

SKU	Tip	Type
AAA-2171A	3mm	Single Cut
AAA-2171B	6mm	Single Cut
AAA-2171C	9mm	Single Cut
AAA-2171D	3mm	Double Cut
AAA-2171E	6mm	Double Cut
AAA-2171F	9mm	Double Cut

**Sinus Lift Osteotome with Marking (6mm, 8mm, 11mm, 15mm)**

SKU	Diameter	Shape
AAA-2174B	3.0mm	Offset, Concave Tip
AAA-2174C	3.3mm	Offset, Concave Tip
AAA-2174D	4.0mm	Offset, Concave Tip
AAA-2174E	5.0mm	Offset, Concave Tip
AAA-2174G	3.0mm	Straight, Concave Tip
AAA-2174H	3.3mm	Straight, Concave Tip
AAA-2174J	4.0mm	Straight, Concave Tip
AAA-2174K	5.0mm	Straight, Concave Tip
AAA-2174M	3.0mm	Offset, Convex Tip
AAA-2174N	3.3mm	Offset, Convex Tip
AAA-2174P	4.0mm	Offset, Convex Tip
AAA-2174Q	5.0mm	Offset, Convex Tip
AAA-2174S	3.0mm	Straight, Convex Tip
AAA-2174T	3.3mm	Straight, Convex Tip
AAA-2174U	4.0mm	Straight, Convex Tip
AAA-2174V	5.0mm	Straight, Convex Tip
AAA-2174A	2.0mm	Offset, Concave Tip
AAA-2174F	2.0mm	Straight, Concave Tip
AAA-2174L	2.0mm	Offset, Convex Tip
AAA-2174R	2.0mm	Straight, Convex Tip

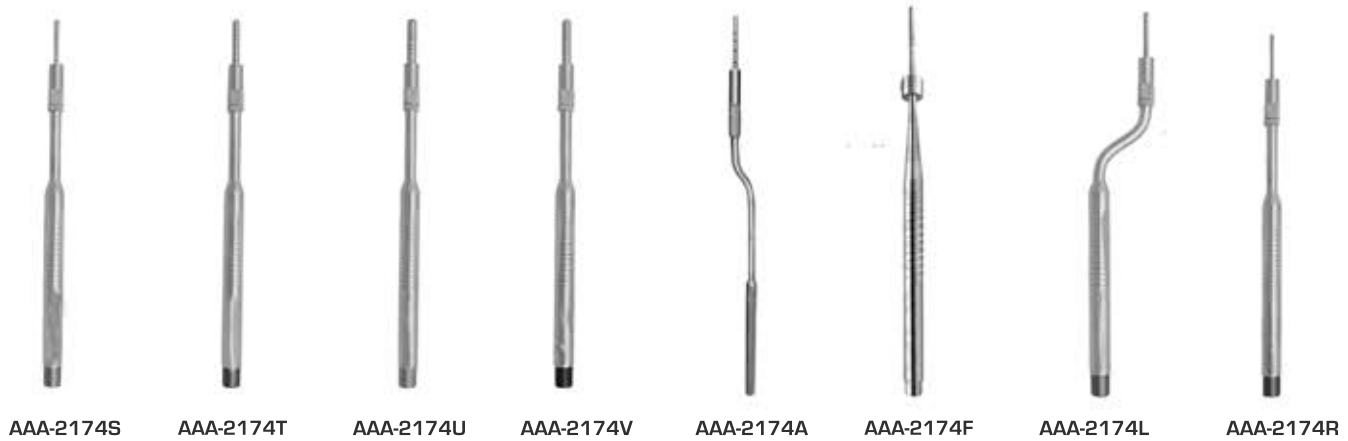
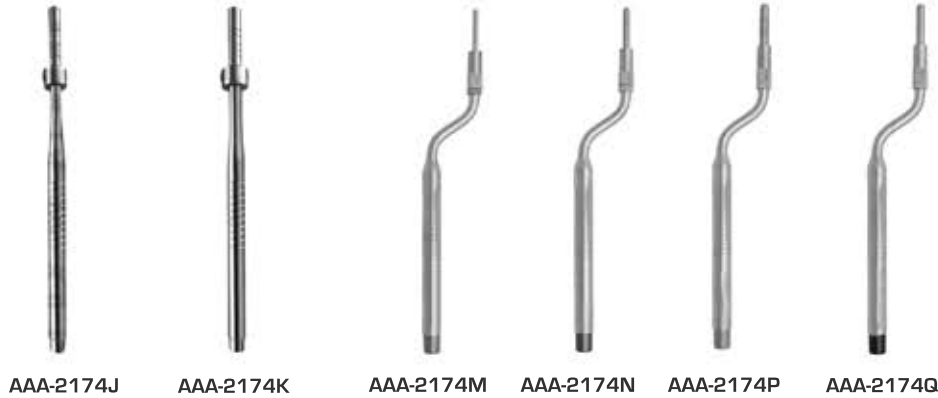
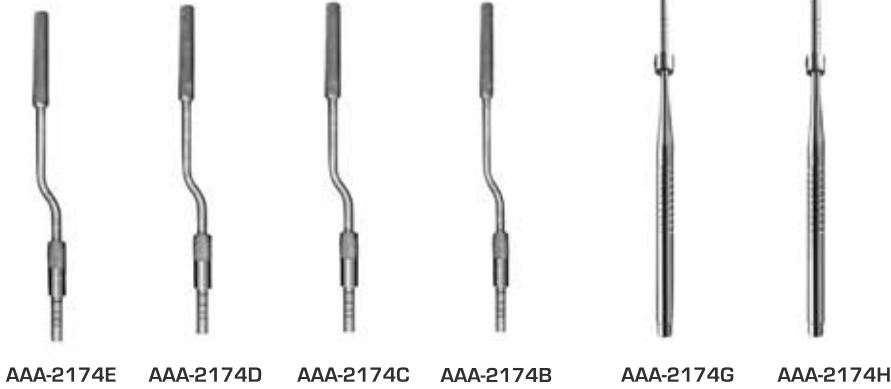

**Solt Periodontal Chisel**

SKU	Fig
AAA-2173A	3/4



AAA-2173A

**Wakefield Bone Chisel**

SKU	Fig
WAK-01W	1W
WAK-02W	2W



WAK-01W



WAK-02W

**Wedelstaedt Enamel Chisel**

SKU	Fig
ENA-0030	39
ENA-0031	40
ENA-0032	41
ENA-0033	42
ENA-0034	43
ENA-0035	44

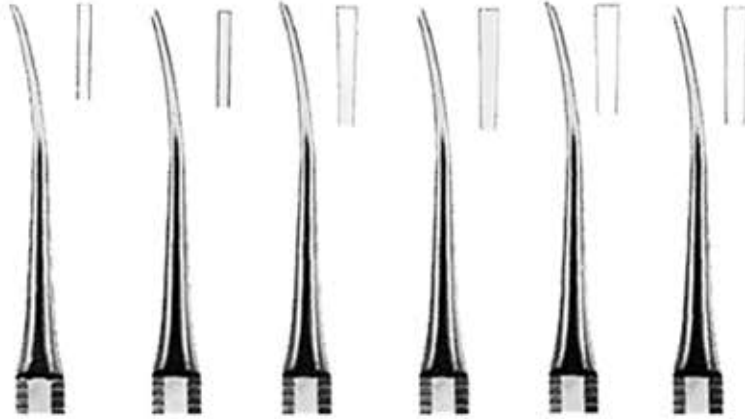

ENA-0030    ENA-0031    ENA-0032    ENA-0033    ENA-0034    ENA-0035

**White Enamel Chisel**

SKU	Fig
ENA-0036	2
ENA-0037	3
ENA-0038	4
ENA-0039	5
ENA-0040	6
ENA-0041	7
ENA-0042	9
ENA-0043	33
ENA-0044	34
ENA-0045	48
ENA-0046	48S



ENA-0037    ENA-0038    ENA-0039    ENA-0040    ENA-0041    ENA-0042    ENA-0043



ENA-0036    ENA-0044    ENA-0045    ENA-0046

# ENDODONTIC SPREADERS

**Endodontic Spreader**

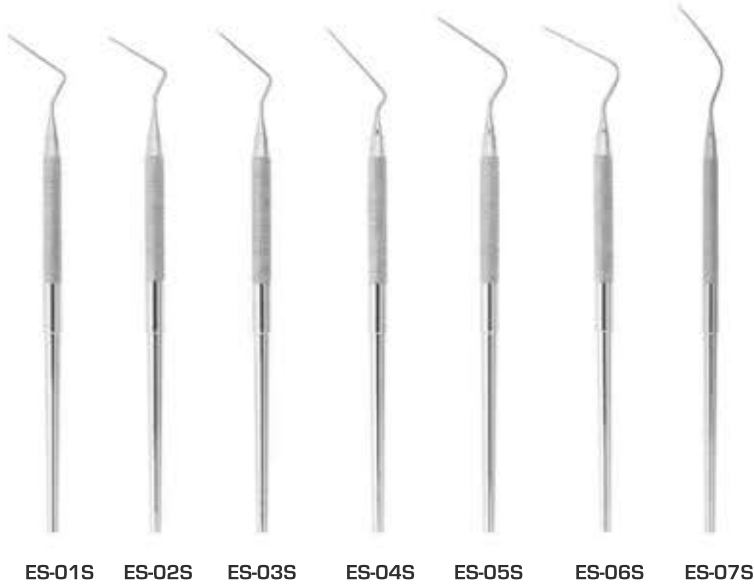

SKU	Fig
ES-01S	1
ES-02S	2
ES-03S	3
ES-04S	4
ES-05S	5
ES-06S	6
ES-07S	7

**Endodontic Spreader**

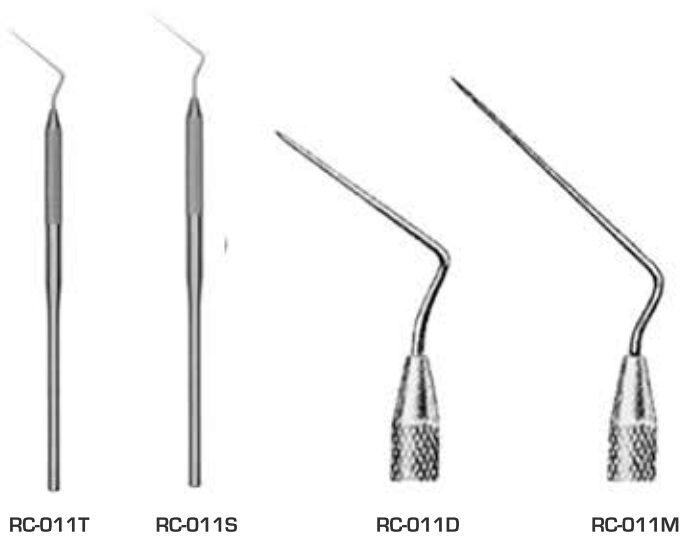

SKU	Fig	Style
RC-011D	D11	Single Ended
RC-011T	D11T	Single Ended
RC-011S	D11TS	Single Ended
RC-011M	MA57	Single Ended

**Endodontic Spreader**

SKU	Fig
ES-25S	25S
RC-01S	0
RC-02S	00
RC-03S	1S
RC-04S	2S
RC-05S	GP1
RC-06S	GP2
RC-07S	GP3

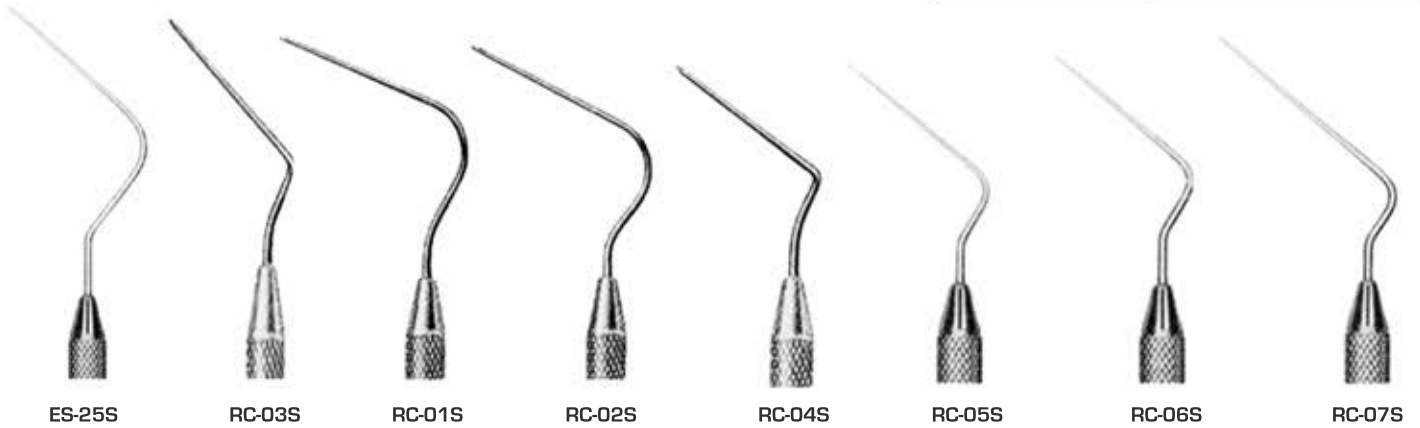

**Steiner Endodontic Spreader**

SKU	Fig
ESS-30S	30



ESS-30S

# EXPLORERS & PROBES



**Briault Explorer**

SKU	Fig	Style
BRA-017A	11	Double Ended



BRA-017A

**Dental Explorer**

SKU	Fig	Style
AAA-2177J	23/6	Double Ended
AAA-2177A	1	Double Ended
AAA-2177K	2	Single Ended
AAA-2177B	2	Double Ended
AAA-2176A	3	Single Ended
AAA-2177F	3	Double Ended
AAA-2177M	5	Double Ended
AAA-2176C	6	Single Ended
AAA-2177N	6	Double Ended
AAA-2177P	7	Double Ended

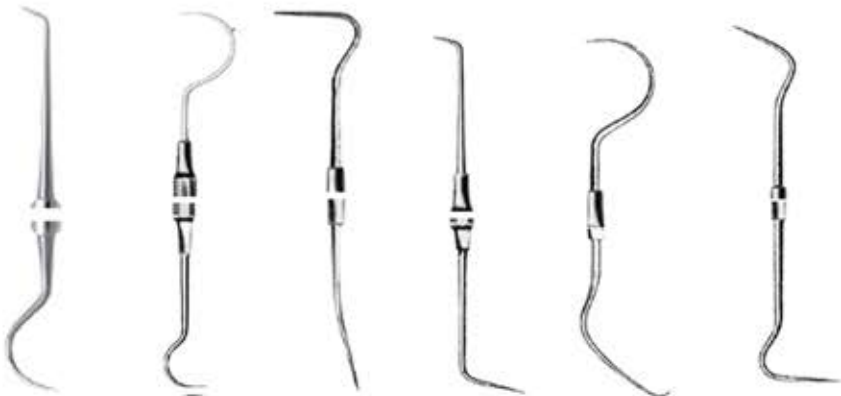

AAA-2177A   AAA-2177B   AAA-2177F   AAA-2177M   AAA-2177N   AAA-2177P



AAA-2177J   AAA-2177K   AAA-2176A   AAA-2176C

Dental Explorer

SKU	Fig	Style
AAA-2176F	8	Single Ended
AAA-2177R	8	Double Ended
AAA-2177S	9	Single Ended
AAA-2179A	10	Single Ended
AAA-2179B	11	Single Ended
AAA-2179C	16	Single Ended
AAA-2179D	17	Single Ended
AAA-2176G	23	Single Ended
AAA-2176R	37	Single Ended
AAA-2176S	48	Single Ended
AAA-2176T	49	Single Ended
AAA-2176N	65	Single Ended
AAA-2176P	66	Single Ended



AAA-2177R



AAA-2176F



AAA-2177S



AAA-2179A



AAA-2179B



AAA-2179C



AAA-2179D



AAA-2176G



AAA-2176R



AAA-2176S



AAA-2176T



AAA-2176N



AAA-2176P

**Dental Explorer**



AAA-2176M AAA-2176D AAA-2176J

SKU	Fig	Style	Handle
AAA-2176Q	5/6	Double Ended	
AAA-2177C	2A	Double Ended	
AAA-2177D	2H	Double Ended	
AAA-2177E	3CH	Double Ended	
AAA-2177G	3ES	Double Ended	
AAA-2176M	5A	Single Ended	Octagonal
AAA-2176D	6A	Single Ended	Octagonal
AAA-2176J	8A	Single Ended	Octagonal
AAA-2176K	EN1	Double Ended	
AAA-2176L	JF17	Double Ended	

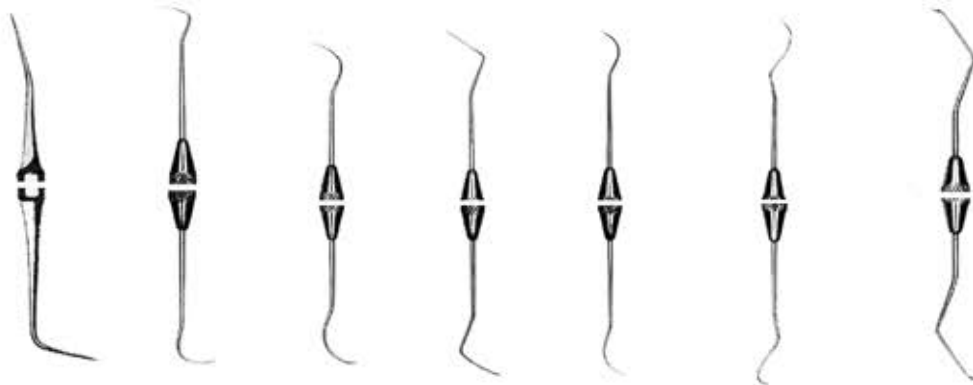

AAA-2176Q AAA-2177C AAA-2177E AAA-2177D AAA-2177G AAA-2176K AAA-2176L

**Dental Explorer**

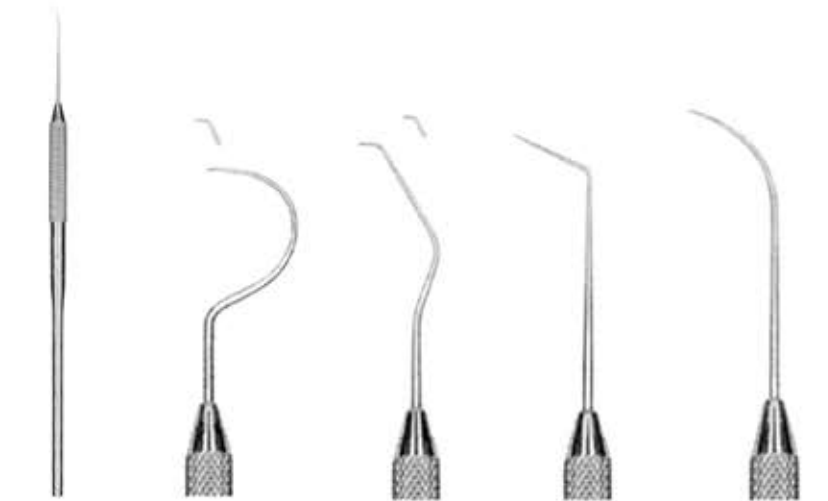

AAA-2177L AAA-2176H AAA-2179E AAA-2176E AAA-2176B

SKU	Fig	Shape
AAA-2177L	3	Round
AAA-2177Q	8	Round
AAA-2177T	9	Round
AAA-2179E	17	Round
AAA-2176H	54	Round
AAA-2176B	3A	Round
AAA-2176E	6L	Round



AAA-2177Q AAA-2177T

**Glickman Measuring Probe**

SKU	Fig
GLK-090A	26G



GLK-090A

**Goldman-Fox Explorer / Measuring Probe**

SKU	Fig
GLD-090A	23/GF



GLD-090A

**Holst A Explorer**

SKU	Fig	Style
HOL-065	65	Single Ended



HOL-065

**Holst Explorer**

SKU	Fig	Style
HOL-055	55	Single Ended



HOL-055

**Hospital Explorer**

SKU	Fig	Style
HSP-140S	14	Single Ended



HSP-140S

**Lange Explorer**

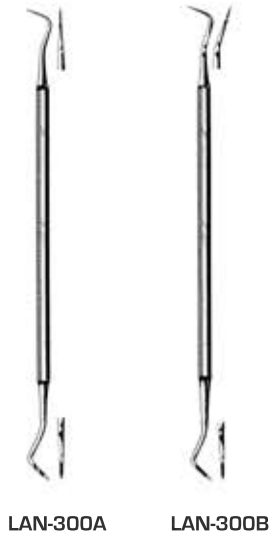

SKU	Fig	Style
LAN-300A	1	Double Ended
LAN-300B	2	Double Ended

**Measuring Probe Single Ended**



SKU	Fig
AAA-2183H	23W
AAA-2183A	CP-2
AAA-2183B	CP-8
AAA-2183C	CP-10
AAA-2183D	CP-11
AAA-2183E	CP-12
AAA-2183F	CP-18

**Merritt Measuring Probe**



MER-090A

SKU	Fig
MER-090A	B

**Michigan Periodontal Probe**



AAA-2183U



MIC-090A



MIC-090B

SKU	Fig	Style
AAA-2183U	0	Single Ended
MIC-090A	PQ-0	
MIC-090B	23/0	

**Nabers Periodontal Pocket Probe**



AAA-2183M



AAA-2183N



AAA-2183P

SKU	Fig
AAA-2183M	1N
AAA-2183N	2N
AAA-2183P	3N

**Old Dominion University Explorer**



AAA-2182A

SKU	Fig	Style
AAA-2182A	11/12DU	Double Ended

**Orban Explorer**



ORB-020A

SKU	Fig	Shape
ORB-020A	20	Round

**Periodontal Pocket Probe**



AAA-4010

AAA-4020

AAA-4050

AAA-4060

SKU	Fig
AAA-4010	CP-C
AAA-4020	CP-12
AAA-4050	CP-11
AAA-4060	CP-12S



**Periodontal Probe / Explorer**



AAA-2183L      AAA-2183K

SKU	Style	Shape
AAA-2183K	Double Ended	Round
AAA-2183L	Single Ended	Round

**Periodontal Probe**



AAA-2183Q      AAA-2183R      AAA-2183S      AAA-2183T

SKU	Fig	Style
AAA-2183Q	8	Single Ended
AAA-2183R	WHO	Single Ended
AAA-2183S	10	Single Ended
AAA-2183T	11	Single Ended

**Scheff Explorer**



SCH-010A

SKU	Fig	Style
SCH-010A	10	Double Ended

**Shepherd Explorer**



SHP-123A

SKU	Fig	Shape
SHP-123A	23	Round

**Thin Williams Explorer / Measuring Probe**



THN-0540      THN-0541      THN-0542      THN-0543      THN-0544

SKU	Fig
THN-0540	6/OW
THN-0541	20F/QOW
THN-0542	23/QOW
THN-0543	23/OW
THN-0544	17/OW

**University Of North Carolina Measuring Probe Single Ended**



AAA-2184A      AAA-2184B

SKU	Fig
AAA-2184A	CP-12
AAA-2184B	CP-15

White Explorer

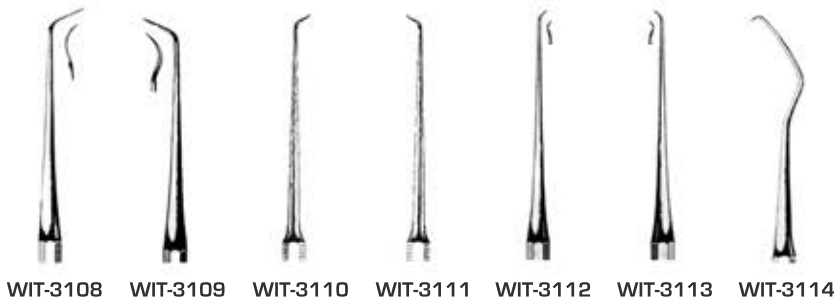

SKU	Fig
WIT-3100	1
WIT-3101	2
WIT-3102	5
WIT-3103	6
WIT-3104	7
WIT-3105	8
WIT-3106	9
WIT-3107	10
WIT-3108	11
WIT-3109	12
WIT-3110	13
WIT-3111	14
WIT-3112	15
WIT-3113	16
WIT-3114	17
WIT-3115	18
WIT-3116	20
WIT-3117	21
WIT-3118	22
WIT-3119	23
WIT-3120	33
WIT-3121	40
WIT-3122	42
WIT-3123	43
WIT-3124	44
WIT-3125	45
WIT-3126	54

**Weston Explorer**

SKU	Fig	Style
WES-012A	12	Double Ended



WES-012A

**Wilkins / Tufts Explorer**

SKU	Fig	Style
AAA-2180A	TU17/23	Double Ended



AAA-2180A

**William-Fox Measuring Probe And Explorer**

SKU	Style
AAA-2183J	Double Ended



AAA-2183J

**Williams Periodontal Probe**

SKU	Fig	Style
AAA-2183V	W	Single Ended



AAA-2183V

# BURNISHERS

**Ball Burnisher**

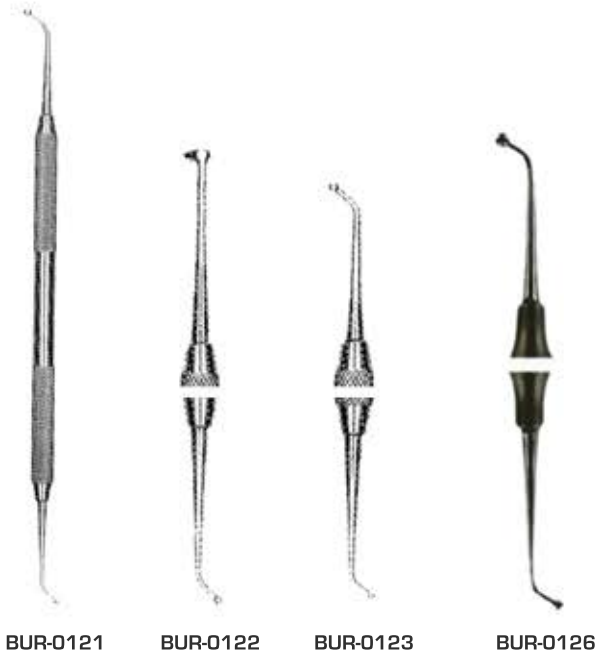

SKU	Fig	Style
BUR-0121	18	Double Ended
BUR-0122	27/29	Double Ended
BUR-0123	26/27S	Double Ended
BUR-0126	B18	Double Ended

**Beavertail Burnisher**



SKU	Fig	Style
BUR-0127	B2D	Double Ended
BUR-0128	B2-29	Double Ended

**Dental Burnisher**

SKU	Fig	Style
BUR-0124	21	Double Ended
BUR-0125	21B	Double Ended

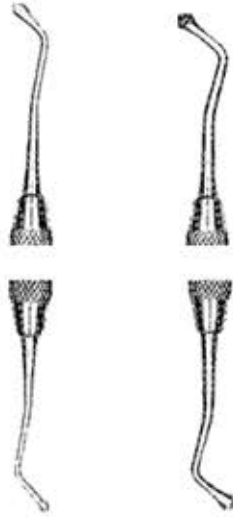

BUR-0124

BUR-0125

**Ladmore Burnisher**

SKU	Fig	Style
BUR-0129	2	Double Ended
BUR-0130	3	Double Ended



BUR-0129

BUR-0130



White Burnisher

SKU	Fig	Style
BUR-0111	1	Single Ended
BUR-0112	2	Single Ended
BUR-0113	3	Single Ended
BUR-0114	5	Single Ended
BUR-0115	25	Single Ended
BUR-0116	26	Single Ended
BUR-0117	27	Single Ended
BUR-0118	28	Single Ended
BUR-0119	29	Single Ended
BUR-0120	31	Single Ended



BUR-0118



BUR-0119



BUR-0120



BUR-0111



BUR-0112



BUR-0113



BUR-0114



BUR-0115



BUR-0116



BUR-0117

# ORTHODONTIC PLIERS

**Abell Contouring Plier**

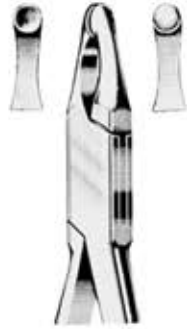

ELL-P013

SKU	Length
ELL-P013	13cm

**Adam Orthodontics Dental Plier**



ADP-125B

SKU	Length
ADP-125B	13cm

**Adams Wire Bending Plier**



DAM-013P

SKU	Length
DAM-013P	13cm

**Aderer Clasp Bending Plier**



DAM-014P

SKU	Length
DAM-014P	14cm

**Aderer Wire Bending Plier**



DAM-011P

DAM-012P

SKU	Length
DAM-011P	11.5cm
DAM-012P	13cm

**Ainsworth Punch Plier**



ARP-165A  
ARP-165B

SKU	Length
ARP-165A	16.5cm
ARP-165B	17.5cm

**Andresen Wire Bending Plier**



AWB-014

SKU	Length
AWB-014	14cm

**Angle Arch Bending Plier**



RCH-013A

SKU	Length
RCH-013A	13cm

**Angle Wire Bending Plier**

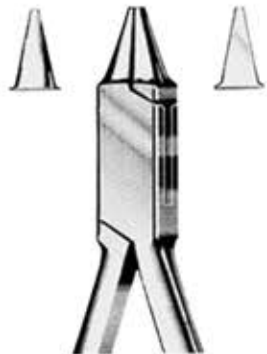

RCH-012A

SKU	Length
RCH-012A	12cm

**Ball Hook Crimping Plier Angled**



CP-B01

SKU	Length
CP-B01	12.5cm

**Bird Beak Orthodontic Plier**



BP-B12A

BP-B15A

SKU	Length
BP-B15A	15.5cm
BP-B12A	12.5cm

**Boehm Telescopic Crown Plier**



BOE-P012

BOE-P015

SKU	Length
BOE-P012	12cm
BOE-P015	15cm

**Bracket Removing Plier**

SKU	Length	Shape	Type
BRP-014A	14cm	Straight	Standard
BRP-014B	14cm	Angled	TC



BRP-014A



BRP-014B

**Distal End Cutter Plier**

SKU	Length	Type
DP-TC11A	11.4cm	TC



DP-TC11A

**Dumont Flat Nose Plier**

SKU	Length	Type
DUM-115T	11.5cm	Tapered
DUM-115B	11.5cm	Broad



DUM-115T



DUM-115B

**Dumont Round Nose Plier**

SKU	Length
DUM-115R	11.5cm



DUM-115R

**Fischer Wire Bending Plier**

SKU	Length
FIC-014A	14cm



FIC-014A

**Flat Nose Plier**

SKU	Length	Type
FLA-125A	12.5cm	Smooth
FLA-125B	12.5cm	Serrated
FLA-145A	14cm	Serrated



FLA-145A

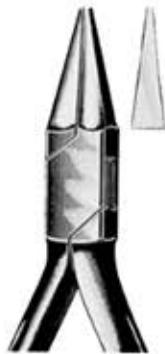

FLA-125A



FLA-125B



**Frevert Contouring Plier**

SKU	Length
FRE-P012	12cm



FRE-P012

**Furrer Copper Ring Removing Plier**

SKU	Length
FUR-C015	15cm



FUR-C015

**Gordon Contouring Plier**

SKU	Length
GOR-P14	14cm



GOR-P14

**Goslee Flat Contour Plier**



GOS-P014

SKU	Length
GOS-P014	14cm

**How Crown Plier**



HOW-014A

HOW-014B

SKU	Length	Type
HOW-014A	14cm	Straight
HOW-014B	14cm	Curved

**Jarabak Light Wire Plier**



JP-LW01

SKU	Length
JP-LW01	14cm

Johnson Contouring Plier



JOH-101

SKU
JOH-101

Korkhaus Ligature Plier



KOR-P015

SKU	Length
KOR-P015	15cm

Langbeck Flat Nose Plier

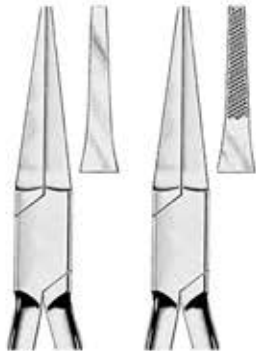

LAN-F014

LAN-F015

SKU	Length	Type
LAN-F014	14cm	Smooth
LAN-F015	14cm	Serrated

**McKellops Sling Forming Plier**



MCK-016P

SKU	Length
MCK-016P	16cm

**McKellops Wire Bending Plier**



MCK-017P

SKU	Length
MCK-017P	17cm

**Module Strokes Separating Plier**



MSP-001A

SKU	Length
MSP-001A	16.5cm

**Nance Orthodontic Plier**



NAN-125

NAN-135

SKU	Length
NAN-125	12.5cm
NAN-135	13.5cm

**Nerve Canal Plier**



NER-PO12

NER-PO13

SKU	Length
NER-PO12	12cm
NER-PO13	12.5cm

**O'Brien Orthodontic Plier**



OBR-135A

OBR-135B

SKU	Length	Type
OBR-135A	13.5cm	Standard
OBR-135B	13.5cm	TC

**Oliver Band Removing Plier**

SKU	Length
OLV-015A	15cm

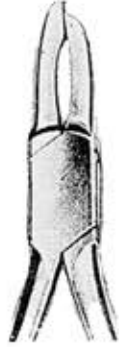

OLV-015A

**Oliver Jones Band Removing Plier**

SKU	Length
OLV-015B	15cm



OLV-015B

**Palmer Rubber Dam Clamp Plier**

SKU	Length
PDP-175A	17.5cm



PDP-175A

**Peeso Contouring Plier**

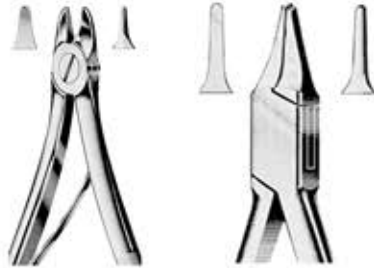

PEE-145P

PEE-012P

SKU	Length
PEE-012P	12cm
PEE-145P	14.5cm

**Reynolds Contouring Plier**



RP-C14A

RP-C14B

SKU	Length	Shape
RP-C14A	14cm	Curved Falcon Tip
RP-C14B	12.5cm	Curved Falcon Tip

**Round Nose Plier**

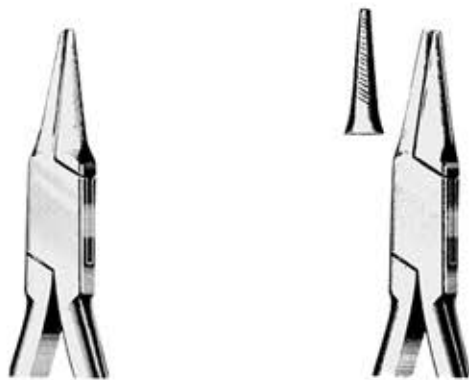

RNP-013A

RNP-013B

SKU	Length	Type
RNP-013A	13cm	Smooth
RNP-013B	13cm	Serrated

**Slim Weingart Plier**



WP-S014

SKU	Length
WP-S014	14cm

**Schwarz Bending Plier**

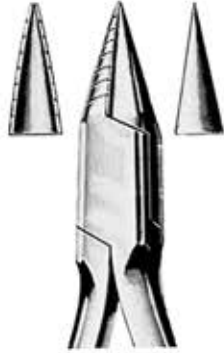

SCH-145A

SKU	Length
SCH-145A	14.5cm

**Schwarz I Bar Bending Plier**



SCH-130A

SKU	Length
SCH-130A	13cm



**Schwarz II Bar Bending Plier**



SCH-130B

SKU	Length
SCH-130B	13cm

**Schwarz III Bar Bending Plier**



SCH-130C

SKU	Length
SCH-130C	13cm

**Triplex Contouring Plier**



LEX-P014

SKU	Length
LEX-P014	14cm

**Tryfus Crown Forming Plier**



FUS-165

SKU	Length
FUS-165	16.5cm

**Tweed Orthodontic Plier**



TFD-010A

SKU	Length
TFD-010A	12cm

**Universal Flat Nose Plier**



UFP-101

SKU	Length
UFP-101	20cm

**Universal Pin Bending Plier**

SKU	Length
UPB-155	15.5cm



UPB-155

**Waldsachs Universal Plier**

SKU	Length
WAL-155	15.5cm



WAL-155

**Weingart Ligature Plier**

SKU	Length
WP-014A	14cm



WP-014A

Young Wire Bending Plier

SKU	Length
YON-P013	13cm



YON-P013

# TONGUE DEPRESSORS

**Davis-Boyle Tongue Depressor**

SKU	Length	Size
TDD-001A	13.5cm	75 x 25mm
TDD-001B	13.5cm	92 x 25mm
TDD-001C	13.5cm	108 x 25mm



TDD-001A



TDD-001B



TDD-001C

**Dingmann Tongue Depressor**

SKU	Length	Size
DIN-256A	13.5cm	65 x 25mm
DIN-256B	13.5cm	70 x 29mm
DIN-256C	13.5cm	80 x 32mm



DIN-256A



DIN-256B



DIN-256C

**Hartmann Tongue Depressor**

SKU	Length	Size
HAR-015A	15cm	72 x 24mm



HAR-015A

**Mclvor Tongue Depressor**

SKU	Length	Size
MTD-S100B	13.5cm	75 x 23mm
MTD-S100C	13.5cm	85 x 25mm
MTD-S100A	13.5cm	100 x 26mm



MTD-S100A



MTD-S100C



MTD-S100B

**Negus Tongue Depressor**

SKU	Length	Size
NEG-030A	13.5cm	70 x 20mm
NEG-030B	13.5cm	80 x 30mm
NEG-030C	13.5cm	95 x 33mm



NEG-030A



NEG-030B



NEG-030C

**Tobold Tongue Depressor**

SKU	Length	Size
TOB-016A	16cm	80 x 25mm
TOB-015A	15cm	83 x 25mm



TOB-016A



TOB-015A



Russel-Davis Tongue Depressor

SKU	Length	Size
RUD-055A	13.5cm	18 x 55mm
RUD-055B	13.5cm	22 x 65mm
RUD-055C	13.5cm	25 x 75mm
RUD-055F	13.5cm	28 x 65mm
RUD-055G	13.5cm	37 x 80mm
RUD-055D	13.5cm	40 x 90mm
RUD-055E	13.5cm	45 x 100mm



RUD-055A



RUD-055B



RUD-055C



RUD-055F



RUD-055G



RUD-055D



RUD-055E

# TOWEL CLAMPS

**Backhaus Towel Clamp**



BTC-101T  
BTC-102T  
BTC-103T  
BTC-104T

SKU	Length	Type
BTC-101T	9cm	Sharp
BTC-102T	11cm	Sharp
BTC-103T	13cm	Sharp
BTC-104T	16cm	Sharp

**Bernhard Towel Clamp**



BTC-L160

SKU	Length	Type
BTC-L160	16cm	Sharp

**Doyen Towel Clamp**



DTC-085A

SKU	Length	Type
DTC-085A	8,5cm	Toothed, Sharp

**Jones Towel Clamp**

SKU	Length	Type
JTC-L85B	5.5cm	Sharp
JTC-L85A	8.5cm	Sharp



JTC-L85B

JTC-L85A

**Peers-Bertram (Modified) Towel Clamp**

SKU	Length
PEB-155T	15.5cm



PEB-155T

**Peers-Bertram Towel Clamp**

SKU	Length
PEB-145T	14.5cm



PEB-145T

**Robin Towel Clamp**

SKU	Length	Type
ROB-135T	13.5cm	Sharp



ROB-135T

**Roeder Towel Clamp**

SKU	Length	Type
ROE-135T	13.5cm	Sharp



ROE-135T

**Schaedel Towel Clamp**

SKU	Length	Type
STC-001B	8.5cm	Straight, Sharp
STC-001A	8.5cm	Curved, Sharp



STC-001B



STC-001A

Tohoko Towel Clamp

SKU	Length
TOK-105T	10.5cm
TOK-135T	13.5cm



TOK-135T



TOK-105T

# MOUTH MIRRORS



**Mouth Mirror (Magnifying)**

SKU	Fig	Diameter
AAA-1387	4	22mm
AAA-1388	5	24mm
AAA-A1386	6	26mm



AAA-A1386



AAA-1388



AAA-1387

**Mouth Mirror (Plane)**

SKU	Fig	Diameter
AAA-1386	4	22mm
AAA-1385	5	24mm
AAA-1384	6	26mm



AAA-1384



AAA-1385



AAA-1386

**Mouth Mirror (Rhodium)**



AAA-2187A



AAA-2187B

SKU	Fig	Diameter
AAA-2187A	4	22mm
AAA-2187B	5	24mm

**Parallelometer Mouth Mirror**



AAA-A1384

SKU
AAA-A1384

**Parallelometer Mouth Mirror Handle**



MMW-010B



MMW-010A

SKU
MMW-010A
MMW-010B

**Parallelometer Mouth Mirror With Handle**



AAA-B1384

SKU
AAA-B1384

**Mouth Mirror Handle**



AAA-B1386



AAA-A1385

SKU	Length	Diameter	Shape
AAA-B1386	12cm	8.0mm	Hexagonal
AAA-A1385	12cm	5.5mm	Octagonal

## Martin-Grip Mouth Mirror Handle

SKU	Length	Diameter	Shape
AAA-B1385	12cm	6.0mm	Round
AAA-B1387	14cm	8.0mm	Round



AAA-B1385



AAA-B1387

## Martin Ergo Mouth Mirror Handle

SKU	Length	Diameter
AAA-A1387	14cm	11mm



AAA-A1387

# CEMENT SPATULAS

**Cement Spatula**

SKU	Fig	Style	Tip	Handle
CMS-A001	1	Single Ended	Pointed	Octagonal
CMS-A002	2	Single Ended	Round	Octagonal
CMS-A003	36	Single Ended	Round	Octagonal
CMS-A004	4	Single Ended	Round	Octagonal
CMS-A005	7	Single Ended	Round	Octagonal
CMS-A006	6	Single Ended	Round	Octagonal
CMS-A009	1	Double Ended	Pointed / Flat	Broad, Flat
CMS-A010	2	Double Ended	Pointed / Flat	Broad, Flat
CMS-A011	3	Double Ended	Pointed / Flat	Broad, Flat
CMS-A012	4	Double Ended	Pointed / Pointed	Broad, Flat
CMS-A007	5	Double Ended	Pointed / Flat	Broad, Flat
CMS-A008	6	Double Ended	Pointed / Flat	Broad, Flat
CMS-A013	1	Double Ended	Round / Round	Octagonal
CMS-A014	2	Double Ended	Pointed / Round	Octagonal
CMS-A015	3	Double Ended	Round / Round	Octagonal



CMS-A003



CMS-A001



CMS-A002



CMS-A004



CMS-A006



CMS-A005



CMS-A013



CMS-A014



CMS-A015



CMS-A009



CMS-A010



CMS-A011



CMS-A012



CMS-A007



CMS-A008

# MATRIX RETAINERS & MATRIX BANDS

**Didner Matrix Retainer**

SKU	Fig
RIX-R011	8P



RIX-R011

**Ivory Matrix Retainer**

SKU	Fig
RIX-R001	1
RIX-R002	12
RIX-R003	12A
RIX-R004	14
RIX-R012	8N

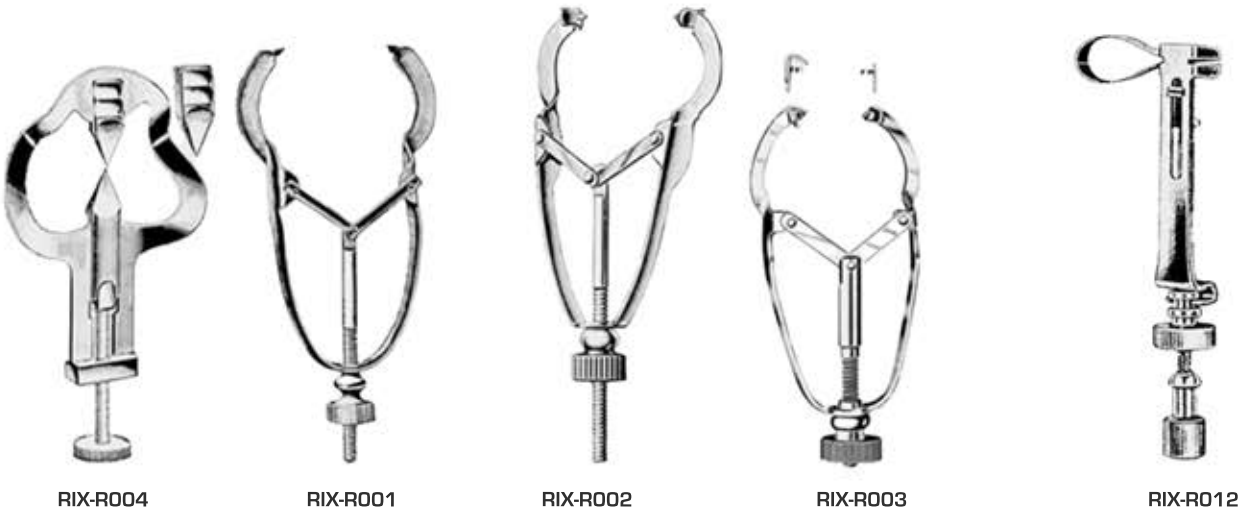

RIX-R004

RIX-R001

RIX-R002

RIX-R003

RIX-R012



**Ivory Matrix Retainer**



RIX-R013  
RIX-R014  
RIX-R015

SKU	Fig	Size
RIX-R013	8	5mm
RIX-R014	8	6mm
RIX-R015	8	7mm

**Matrix Band For Molars**



RIX-R005



RIX-R006



RIX-R007



RIX-R024



RIX-R025



RIX-R026



RIX-R027

SKU	Fig
RIX-R005	1
RIX-R006	2
RIX-R007	3
RIX-R024	7
RIX-R025	8
RIX-R026	9
RIX-R027	10

**Matrix Band For Premolars**



RIX-R008



RIX-R009

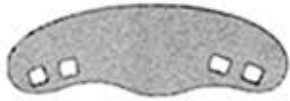

RIX-R010



RIX-R028



RIX-R029



RIX-R030

SKU	Fig
RIX-R008	4
RIX-R009	5
RIX-R010	6
RIX-R028	11
RIX-R029	12
RIX-R030	13

**Nystroem Matrix Retainer**

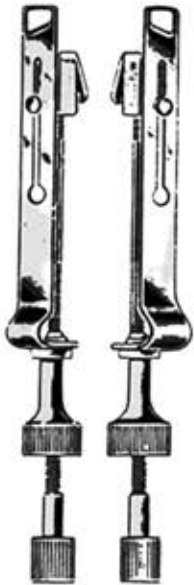

RIX-R017



RIX-R018



RIX-R019

SKU	Style
RIX-R017	Pair
RIX-R018	Left
RIX-R019	Right

**Tofflemire Matrix Band**

SKU	Fig
RIX-R020	1
RIX-R021	2
RIX-R022	3
RIX-R023	13



RIX-R020



RIX-R021



RIX-R022



RIX-R023

**Tofflemire Matrix Retainer**

SKU	Type
RIX-R016	Universal



RIX-R016

# PLASTER & ALGINATE SPATULAS

## Flexible Spatula

SKU	Fig	Length
PAS-F001	3	18.5cm
PAS-F002	4	19.5cm
PAS-F003	5	21.5cm
PAS-F004	6	20.5cm
PAS-F005	8	20cm
PAS-F006	9	22.5cm



## Rigid Spatula

SKU	Fig	Length
PAS-R001	1	18.5cm
PAS-R002	2	18cm
PAS-R003	7	19.5cm

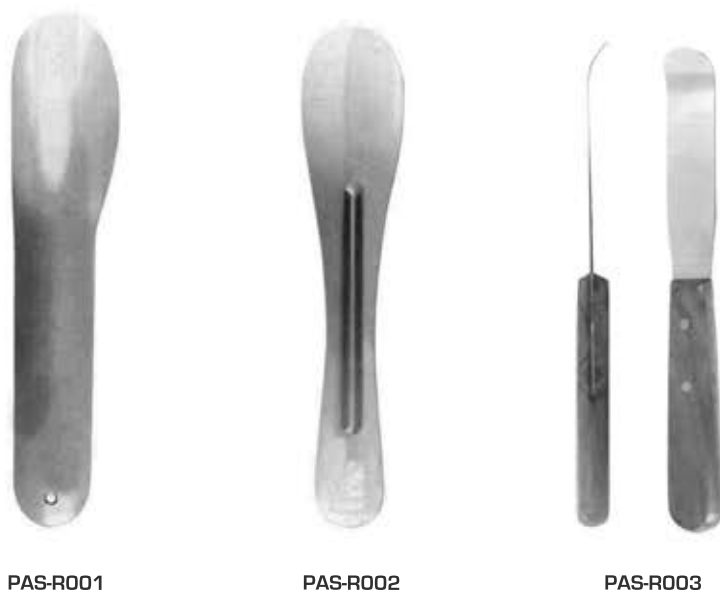

# RUBBER DAM CLAMPS & FORCEPS

**Ivory Rubber Dam Clamp**

SKU	Fig
RDC-L001	26
RDC-L002	27
RDC-L003	28
RDC-L004	29
RDC-L005	30
RDC-L006	31
RDC-L007	51
RDC-L008	60



RDC-L001



RDC-L002



RDC-L003



RDC-L004



RDC-L005



RDC-L006



RDC-L007



RDC-L008

**Ainsworth Rubber Dam Forceps**

SKU	Length
RDC-F001	17cm



RDC-F001

**Brewer Rubber Dam Forceps**

SKU	Length
RDC-F002	17.5cm



RDC-F002

**Ivory Rubber Dam Forceps**

SKU	Length
RDC-F003	16cm



RDC-F003

**Ivory Rubber Dam Forceps, Flat**

SKU	Length
RDC-F004	17cm



RDC-F004



**Palmer Rubber Dam Forceps**

SKU	Fig
RDC-F005	17.5cm



RDC-F005

**Stokes Rubber Dam Forceps**

SKU	Length
RDC-F006	17.5cm

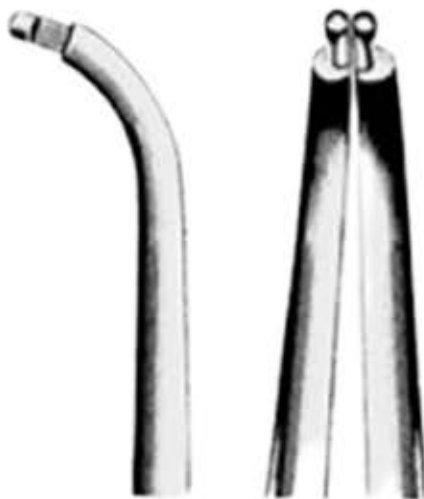

RDC-F006

Rubber Dam Frame

SKU
RDC-F007

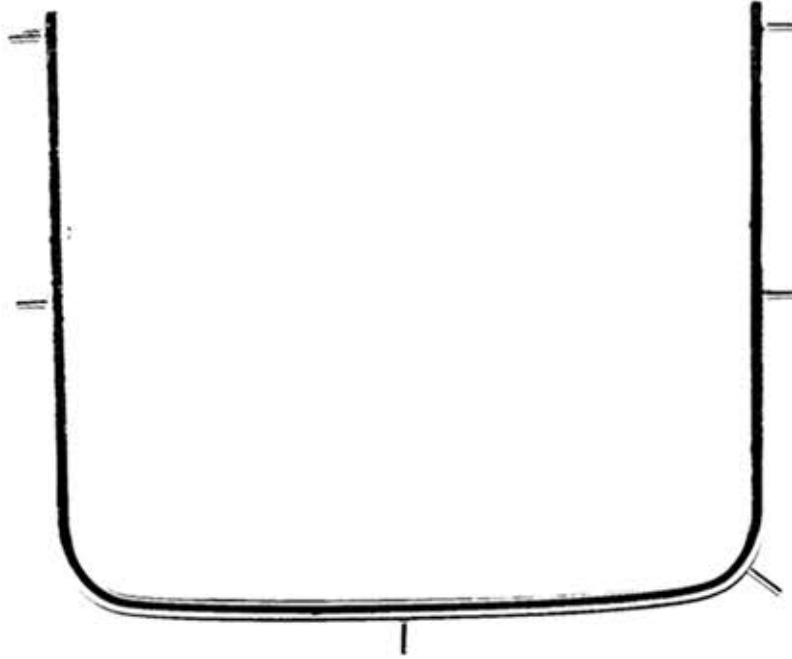

RDC-F007

# CROWN REMOVERS

**Automatic Crown Remover With Two Points**



CRW-R909

<b>SKU</b>
CRW-R909

**Beebee Crown Scissors**

SKU	Length	Shape	Blades
CRW-R901	110mm	Curved	Sharp / Sharp
CRW-R902	110mm	Straight	Sharp / Sharp
CRW-R903	110mm	Curved	Wide Blades, B/B
CRW-R904	110mm	Curved	Wide Blades, B/B, One Blade Serrated



CRW-R901



CRW-R902



CRW-R903



CRW-R904

**Crown Spreader**

SKU	Shape
CRW-R910	Hook Shaped



CRW-R910

**Furrer Crown Ring Removing Plier**

SKU	Length
CRW-R905	145mm



CRW-R905

## Mershon Crown Depressor

SKU	Length
CRW-R908	145mm



CRW-R908

## Miller Crown Remover

SKU
CRW-R911

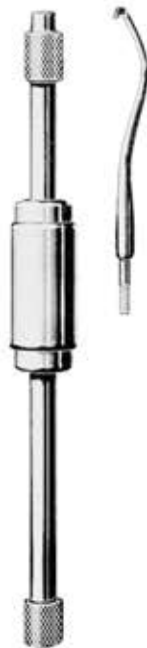

CRW-R911

**Monfort Crown Slitter**

SKU
CRW-R912



CRW-R912

**Morrell Crown Remover With Three Points**

SKU
CRW-R907



CRW-R907

**Planert Crown Dilating Forceps**

SKU	Length
CRW-R906	140mm



CRW-R906

**Schroeder Crown Remover**

SKU
CRW-R913



CRW-R913



## Treymann Crown Remover

SKU	Length	Shape
CRW-R900	255mm	Curved



CRW-R900

# WAX, PORCELAIN & MODELING INSTRUMENTS

**Antkoviak Wax Knife**

SKU	Length
ANT-125	12.5cm



ANT-125

**Beale Wax Spatula**

SKU	Fig
BEA-07A	7A



BEA-07A

**Con Scodellino Wax Knife**

SKU	Fig	Length
CWK-125A	1	12.5cm
CWK-117A	2	17cm



CWK-125A



CWK-117A

**Ermert Wax Spatula**

SKU	Handle
EWE-W001	Wood
EWE-W002	Metal



EWE-W001



EWE-W002

**Fahnestock Wax Knife**

SKU	Fig	Length
FWK-L125	1	12.5cm
FWK-L117	2	17cm



FWK-L125

FWK-L117

**Frahm Modeling Instrument**

SKU	Fig
FMH-L01	6/10
FMH-L02	10
FMH-L03	1
FMH-L04	2
FMH-L05	6

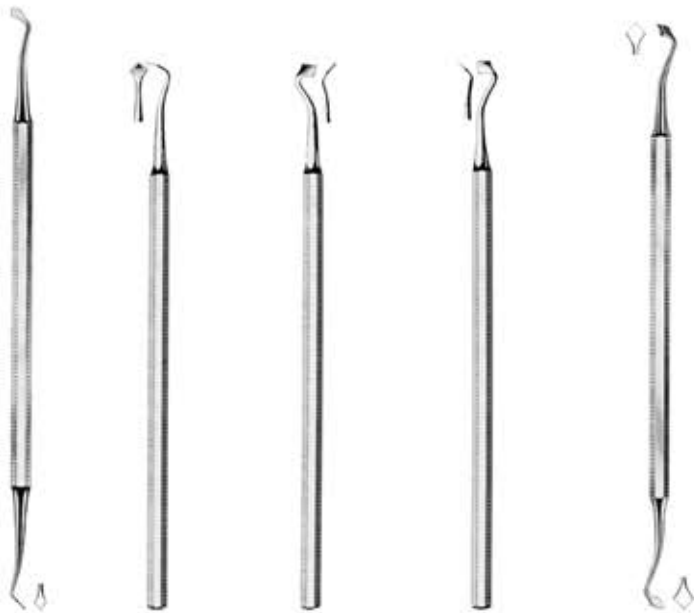

FMH-L03

FMH-L04

FMH-L05

FMH-L02

FMH-L01

Gisy Wild Wax Knife

SKU	Length
GWK-015	15cm



GWK-015

Gritman Plaster Knife

SKU	Fig	Length
PK-L217	2	17cm



PK-L217

**Lessmann Wax Knife**

SKU	Fig	Length
LWK-125A	1	12.5cm
LWK-117A	2	17cm



LWK-125A

LWK-117A

**Medicon Modeling Instrument**

SKU	Length
CON-M17	17cm



CON-M17

## Plaster Knife

SKU	Fig	Length
PK-L117	1	17cm
PK-L316	3	16cm
PK-L416	4	16cm



PK-L117



PK-L316



PK-L416



# IMPRESSION TRAYS

Impression Tray Upper Non-Perforated

SKU	Size	Length	Width
IMT-F001	XS	46mm	63mm
IMT-F002	S	50mm	65mm
IMT-F003	M	56mm	68mm
IMT-F004	L	59mm	73mm
IMT-F005	XL	62mm	76mm



IMT-F001



IMT-F002



IMT-F003



IMT-F004



IMT-F005

Impression Tray Lower Non-Perforated

SKU	Size	Length	Width
IMT-F006	XS	52mm	63mm
IMT-F007	S	54mm	72mm
IMT-F008	M	56mm	76mm
IMT-F009	L	60mm	78mm
IMT-F010	XL	65mm	80mm



IMT-F006



IMT-F007



IMT-F008



IMT-F009



IMT-F010

Impression Tray Upper Perforated

SKU	Size	Length	Width
IMT-F011	XS	46mm	63mm
IMT-F012	S	50mm	65mm
IMT-F013	M	56mm	68mm
IMT-F014	L	59mm	73mm
IMT-F015	XL	62mm	76mm



IMT-F011



IMT-F012



IMT-F013



IMT-F014



IMT-F015

**Impression Tray Lower Perforated**

SKU	Size	Length	Width
IMT-F016	XS	52mm	63mm
IMT-F017	S	54mm	72mm
IMT-F018	M	56mm	76mm
IMT-F019	L	60mm	78mm
IMT-F020	XL	65mm	80mm



IMT-F016



IMT-F017



IMT-F018



IMT-F019



IMT-F020

**Impression Tray Form C1/2**

SKU	Fig
IMT-F026	1 For Upper Jaw Right / Lower Jaw Left



IMT-F026

**Impression Tray Form C1/3**

SKU	Fig
IMT-F027	2 For Upper Jaw Right / Lower Jaw Left



IMT-F027

**Impression Tray Form C1/4**

SKU	Fig
IMT-F028	3 For Upper Jaw Right / Lower Jaw Left



IMT-F028

**Impression Tray Form C1/5**

SKU	Fig
IMT-F029	4 For Upper Jaw Right / Lower Jaw Left



IMT-F029

**Impression Tray Form C1/6**

SKU	Fig
IMT-F030	1 For Upper Jaw Left / Lower Jaw Right



IMT-F030

**Impression Tray Form C1/7**

SKU	Fig
IMT-F031	2 For Upper Jaw Left / Lower Jaw Right



IMT-F031

**Impression Tray Form C1/8**

SKU	Fig
IMT-F032	3 For Upper Jaw Left / Lower Jaw Right



IMT-F032

**Impression Tray Form C1/9**

SKU	Fig
IMT-F033	4 For Upper Jaw Left / Lower Jaw Right



IMT-F033

**Impression Tray Universal**

SKU
IMT-F034



IMT-F034

**Impression Tray Stolley**

SKU
IMT-F036



IMT-F036



# PERIOSTEAL DENTAL ELEVATORS

### Alijberg Periosteal Dental Elevator

SKU	Length
PDE-R001	18cm



PDE-R001

### Allen Iglhaut Periosteal Dental Elevator

SKU	Length
PDE-R002	18cm



PDE-R002

### Alley Periosteal Dental Elevator

SKU	Length
PDE-R003	20cm



PDE-R003

### Bennet Periosteal Dental Elevator

SKU	Length	Tip
PDE-R004	17cm	Sharp/Blunt



PDE-R004

**Emons Periosteal Dental Elevator**

SKU	Length
PDE-R005	17cm



PDE-R005

**Freer Periosteal Dental Elevator**

SKU	Length	Diameter	Tip
FER-190	19cm	5mm	Sharp/Blunt



FER-190

## Henahan Periosteal Dental Elevator

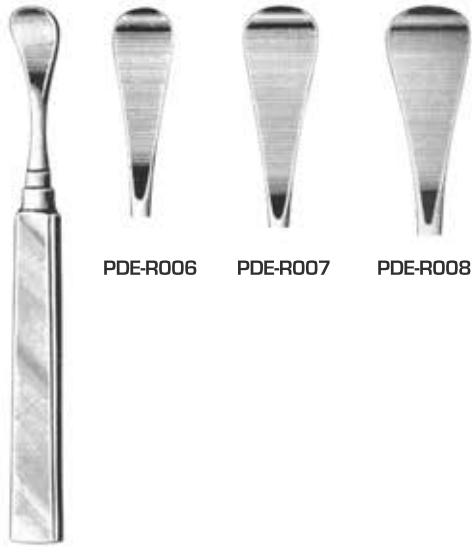

PDE-R006 PDE-R007 PDE-R008

SKU	Length	Diameter	Tip
PDE-R006	17cm	10mm	Semi-Sharp
PDE-R007	17cm	12mm	Semi-Sharp
PDE-R008	17cm	15mm	Semi-Sharp

## Iglhaut Periosteal Dental Elevator



PDE-R009

SKU	Length
PDE-R009	18cm

### Kahre-Williger Periosteal Dental Elevator

SKU	Length	Diameter
PDE-R010	16.5cm	4mm
PDE-R011	16.5cm	5mm

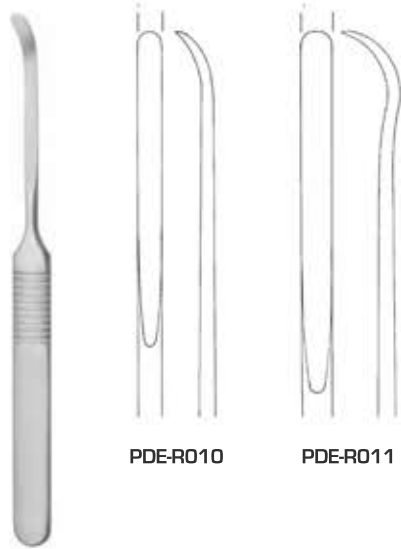

PDE-R010

PDE-R011

### Korner/Westermann Periosteal Dental Elevator

SKU	Length
PDE-R012	16.5cm



PDE-R012

### Molt Periosteal Dental Elevator

SKU	Length
PDE-R013	17cm
MR-180A	18cm



PDE-R013



MR-180A

### Ohl Periosteal Dental Elevator

SKU	Length
PDE-R014	17.5cm



PDE-R014

**Prichard Periosteal Dental Elevator**

SKU	Length
PER-170	17cm



PER-170

**Seldin Periosteal Dental Elevator**

SKU	Length	Tip
PDE-R015	19cm	Sharp/Sharp
PDE-R016	19.5cm	Sharp/Blunt



PDE-R015



PDE-R016



**West Bone Periosteal Dental Elevator**

SKU	Length
PDE-R017	18cm



PDE-R017

**Williger Periosteal Dental Elevator**

SKU	Length	Diameter	Tip
WR-140A	16cm	4mm	Blunt
PDE-R018	16cm	5.5mm	Blunt
PDE-R019	16cm	7mm	Blunt

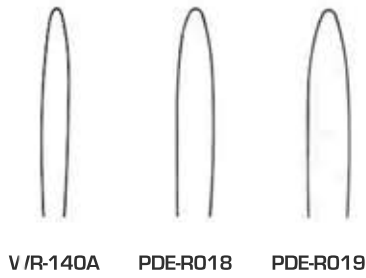

V/R-140A

PDE-R018

PDE-R019

# DENTAL SYRINGES

**Breech Loading Syringe**

<b>SKU</b>
BLS-100



BLS-100

**Cylinder Cartridge Syringe**

SKU	Size	Description
CCS-S001	1.8cc	Without Aspiration
CCS-S002	1.8cc	With Aspiration
CCS-S003	2.2cc	With Aspiration



CCS-S001



CCS-S002



CCS-S003

**Dental Aspirating Syringe**

SKU
AAA-2189



AAA-2189

**Metal Water Syringe With 1 Cannula (Luer Lock)**

SKU
WSC-S02



WSC-S02

**Water Syringe With 1 Cannula (Luer Lock)**

SKU
WSC-S01



WSC-S01

# MALLETS

**Cottle Mallet**



MH-122

SKU	Length	Weight	Diameter	Type
MH-122	18.5cm	235g	30mm	1 Side Flat, 1 Side Convex

**Hajek Mallet**



MH-121

SKU	Length	Weight	Diameter
MH-121	22cm	135g	27mm

**Herbert Mallet**

SKU	Length	Weight	Diameter
MH-127	19cm	215g	25mm



MH-127

**Mallet**

SKU	Length	Weight	Diameter
MH-123	16.5cm	80g	22mm
MH-124	19cm	155g	25mm
MH-125	18.5cm	135g	25mm



MH-125



MH-124



MH-123

**Mead Mallet**

SKU	Length	Weight	Diameter
MH-128	18cm	190g	20mm



MH-128

**Williger Mallet**

SKU	Length	Weight	Diameter
MH-126	16.5cm	140g	20mm



MH-126



# TWEEZERS & FORCEPS

**Adson Brown Forceps**

SKU	Length	Tip
S79-T012	12cm	7x8 Teeth
S79-T015	15cm	7x8 Teeth



S79-T012



S79-T015

**Adson Forceps**

SKU	Length	Tip	Teeth Size	Type
S78-013	12cm	1x2 Teeth	Regular	Standard
S78-030TR	12cm	No Teeth		TC



S78-013



S78-030TR

**Albrecht Tweezer**

SKU	Length	Tip
AT-16SR	16cm	Serrated, Round Tip
AT-16SP	16cm	Serrated, Pointed Tip



AT-16SR

AT-16SP

**Allen Tooth Tweezer**

SKU	Length	Tip
ATT-018A	18cm	Smooth

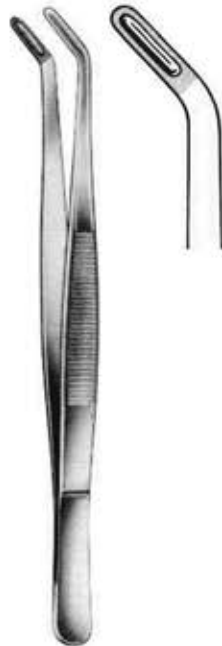

ATT-018A

**Brophy Forceps**

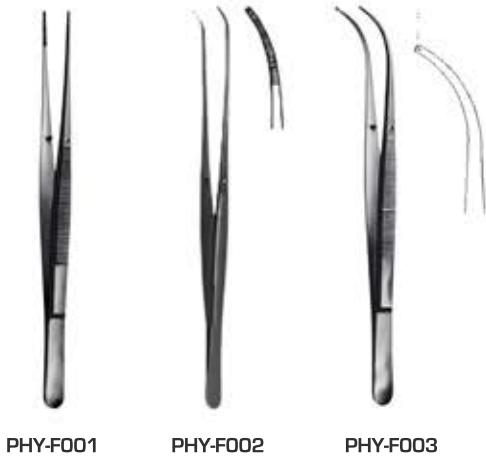

PHY-F001

PHY-F002

PHY-F003

SKU	Length	Shape	Tip
PHY-F001	18cm	Straight	Serrated, Delicate
PHY-F002	18cm	Curved	Serrated, Delicate
PHY-F003	20cm	Curved	Serrated, Delicate

**CK1 Dental Tweezer**

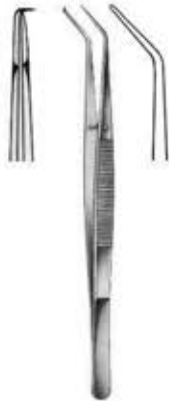

CK-T001

SKU	Length	Tip
CK-T001	15cm	Smooth, Right Sided

**CK2 Dental Tweezer**

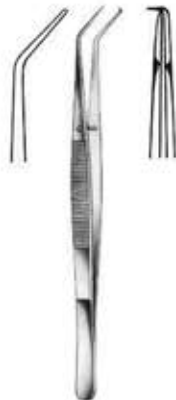

CK-T002

SKU	Length	Tip
CK-T002	15cm	Smooth, Left Sided

**Cushing Forceps**



CF-S018

SKU	Length	Tip	Type
CF-S018	18cm	Cross Serrated	TC

**Debakey Atraumatic Forceps**



BAK-F15B



BAK-F15A



BAK-F15C

SKU	Length	Tip	Shape	Diameter
BAK-F15A	15cm	Serrated	Straight	1.5mm
BAK-F15B	15cm	Serrated	Straight	2mm
BAK-F15C	15cm	Serrated	Angular	2mm

**Dissecting Forceps**



DFR-018A



DFR-018B

SKU	Length	Shape
DFR-018A	18cm	Straight
DFR-018B	17.5cm	Curved

**Dressing Forceps**



DF-102

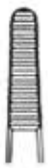

DF-300



DF-106



DF-108

SKU	Length	Tip
DF-102	11.5cm	Serrated
DF-300	13cm	Serrated
DF-106	14.5cm	Serrated
DF-108	16cm	Serrated

**Dressing Forceps**

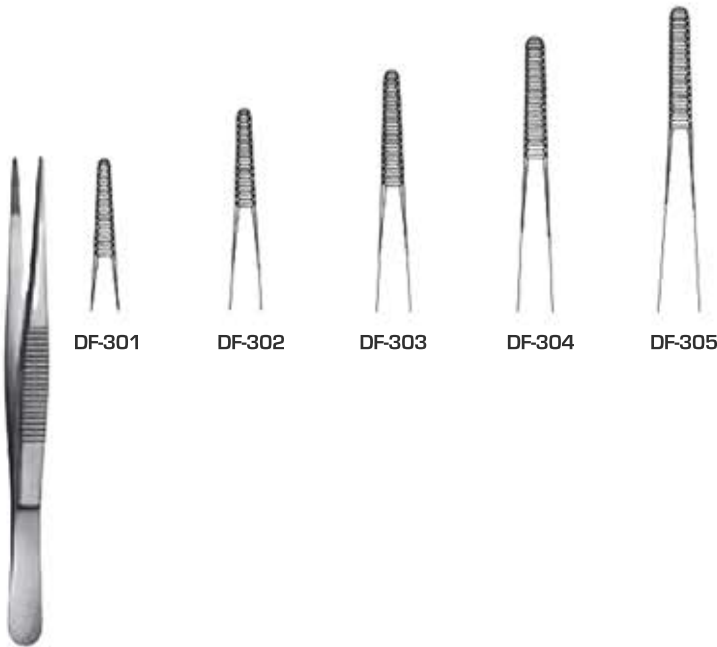

SKU	Length	Shape	Tip
DF-301	11.5cm	Straight	Serrated, Delicate
DF-302	13cm	Straight	Serrated, Delicate
DF-303	14.5cm	Straight	Serrated, Delicate
DF-304	16cm	Straight	Serrated, Delicate
DF-305	18cm	Straight	Serrated, Delicate
DF-306	13cm	Curved	Serrated, Delicate
DF-307	14cm	Curved	Serrated, Delicate

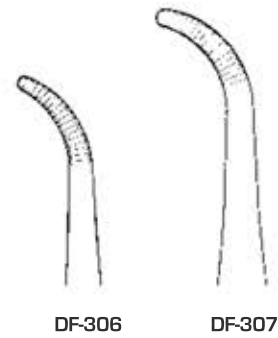

**Flag Dental Tweezer**

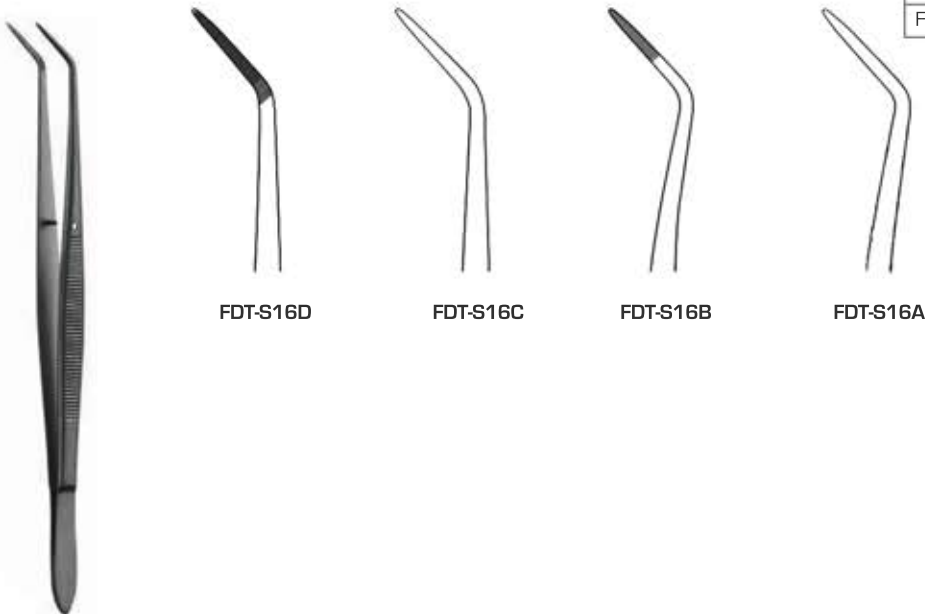

SKU	Length	Fig
FDT-S16A	16cm	1
FDT-S16B	16cm	2
FDT-S16C	16cm	3
FDT-S16D	16cm	4

**Gerald Tissue Forceps**

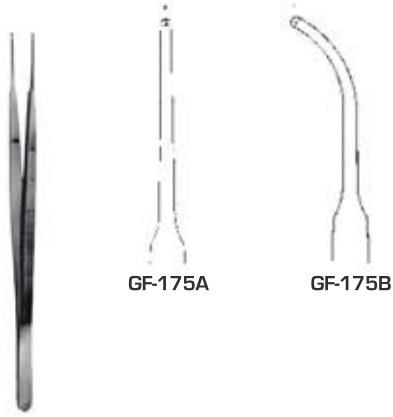

SKU	Length	Shape	Tip
GF-175A	17.5cm	Straight	1x2 Teeth
GF-175B	17.5cm	Curved	1x2 Teeth

**GF1 Dental Tweezer**



GF-T002

SKU	Length	Tip
GF-T002	16cm	Smooth, Left Sided

**GF2 Dental Tweezer**



GF-T001

SKU	Length	Tip
GF-T001	16cm	Smooth, Right Sided



**Gillies Tissue Forceps**



S75-010A

SKU	Length	Shape	Tip
S75-010A	15.5cm	Straight	1x2 Teeth, Cross Serrated

**Gross Dressing Forceps**



AAA-0422



AAA-0423



AAA-0422R



AAA-0423R

SKU	Length	Tip	Shape
AAA-0422	20cm	Serrated	Straight, Without Ratchet
AAA-0422R	20cm	Serrated	Straight, With Ratchet
AAA-0423	20cm	Serrated	Curved, Without Ratchet
AAA-0423R	20cm	Serrated	Curved, With Ratchet

**Kopp Dental Tweezer**

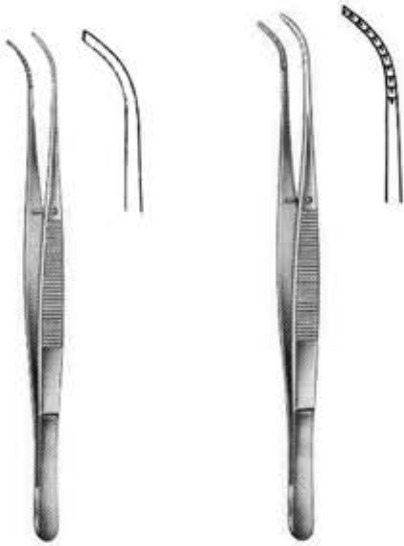

KOP-T115

KOP-T116

SKU	Length	Tip
KOP-T115	15.5cm	Smooth
KOP-T116	15.5cm	Serrated

**Landgraf Dental Tweezer**

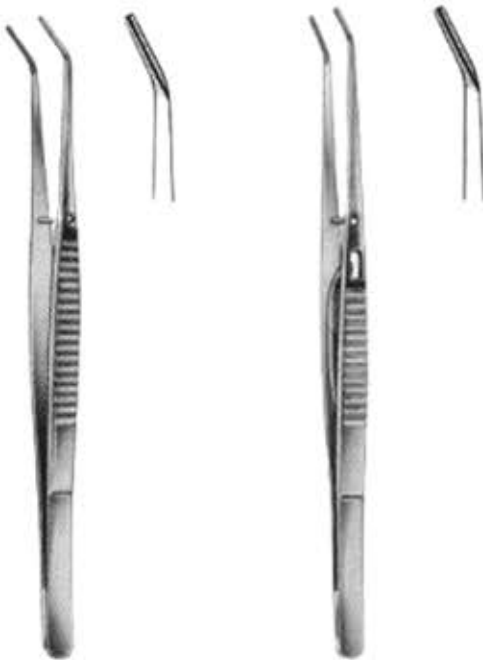

LTT-S15A

LTT-S15B

SKU	Length	Tip
LTT-S15A	15cm	Serrated
LTT-S15B	15cm	Smooth

**London College Tooth Tweezer**

SKU	Length	Tip
LCT-015A	15cm	1
LCT-015B	15cm	3
LCT-015C	15cm	5
LCT-015D	15cm	5, With Lock
LCT-015E	15cm	8, With Lock

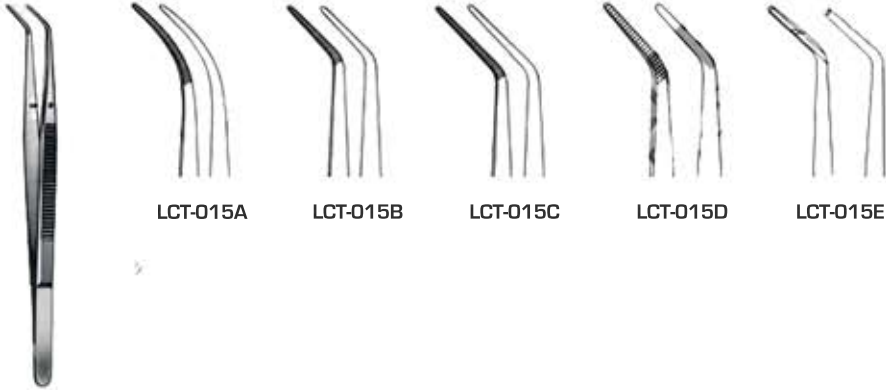

LCT-015A      LCT-015B      LCT-015C      LCT-015D      LCT-015E

**Lister Sponge And Dressing Forceps**

SKU	Length
LSD-013A	13cm
LSD-016A	16cm



LSD-013A      LSD-016A

**McIndoe Dissecting Forceps**

SKU	Length	Shape	Shape
S74-F151	15cm	Straight	1x2 Teeth, Serrated, Delicate



S74-F151

**Meriam Dental Tweezer**



MTT-016D



MTT-016A



MTT-016C

SKU	Length	Fig
MTT-016D	16cm	1
MTT-016A	16cm	2
MTT-016C	16cm	3

**Micro Dressing And Suture Forceps**



- MDSF-F009
- MDSF-F010
- MDSF-F011
- MDSF-F013
- MDSF-F014

SKU	Length	Tip	Shape
MDSF-F009	9cm	Serrated	Straight
MDSF-F010	10.5cm	Serrated	Straight
MDSF-F011	11.5cm	Serrated	Straight
MDSF-F013	13cm	Serrated	Straight
MDSF-F014	14.5cm	Serrated	Straight

**Micro-Adson Forceps**



S80-015P



S80-015



S80-011



S80-011D

SKU	Length	Type	Type
S80-015P	12cm	Standard	Serrated With Platform, Delicate
S80-011	12cm	Standard	1x2 Teeth
S80-015	15cm	Standard	Serrated, Delicate
S80-011D	15cm	Standard	1x2 Teeth

**Perry Dental Tweezer**



AAA-0193



AAA-0192

SKU	Length	Shape
AAA-0192	12.5cm	Straight
AAA-0193	12.5cm	Curved

**Potts Smith Dressing Forceps**

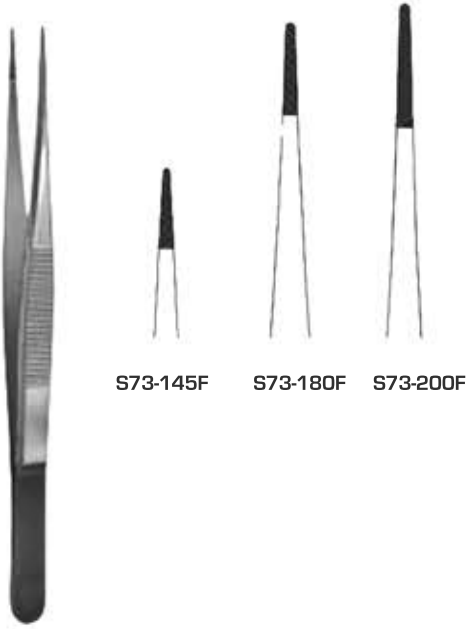

SKU	Length	Tip	Type
S73-145F	14.5cm	Cross Serrated	TC
S73-200F	20cm	Cross Serrated	TC
S73-180F	18cm	Cross Serrated	TC

**Semken Tissue Forceps**

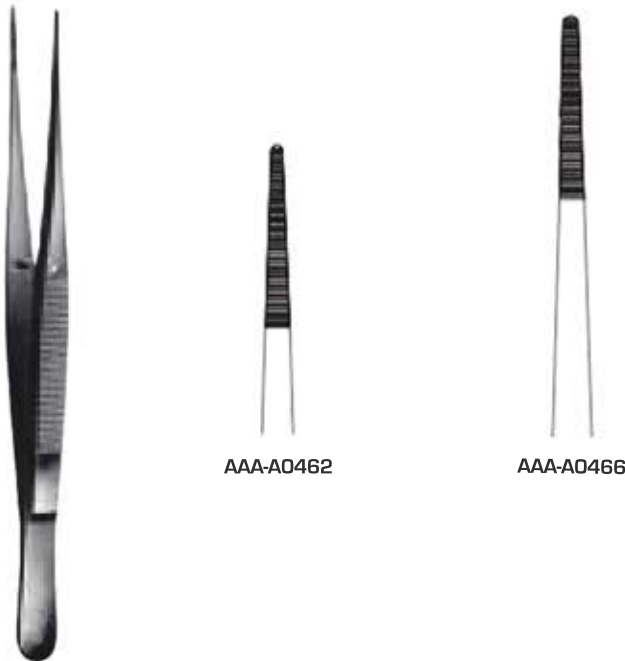

SKU	Length	Tip
AAA-A0462	12.5cm	Serrated, Delicate
AAA-A0466	15cm	Serrated, Delicate

**Standard Forceps**

SKU	Length	Tip	Type
STA-T145	14.5cm	Cross Serrated	TC



STA-T145

**Suture Forceps**

SKU	Length	Shape
SUT-F15	15cm	Angulated



SUT-F15

**Tissue Forceps**

SKU	Length	Tip	Type
AAA-TS11	11.5cm	1x2 Teeth	Straight
AAA-TS12	13cm	1x2 Teeth	Straight
AAA-TS13	14.5cm	1x2 Teeth	Straight
AAA-TS14	14.5cm	1x2 Teeth	Curved
AAA-TS15	16cm	1x2 Teeth	Straight
AAA-TS16	18cm	1x2 Teeth	Straight
AAA-TS17	20cm	1x2 Teeth	Straight

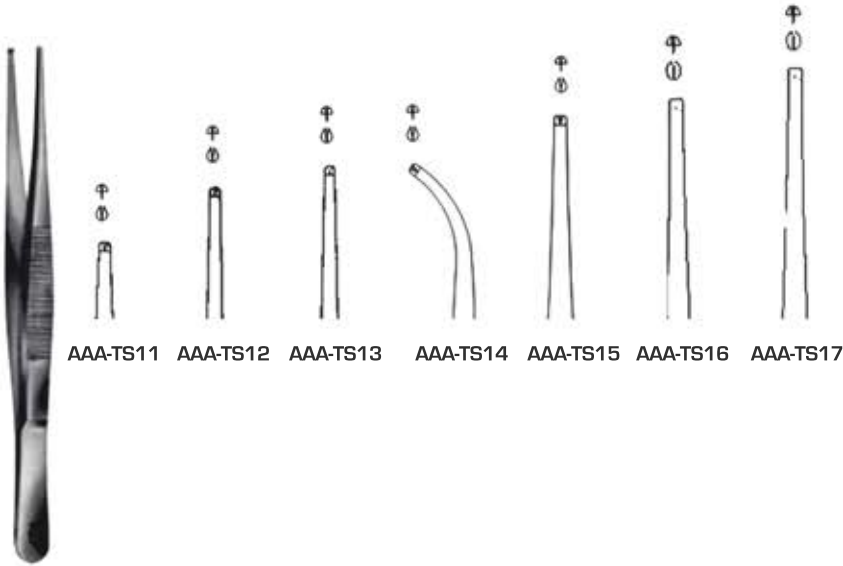

AAA-TS11 AAA-TS12 AAA-TS13 AAA-TS14 AAA-TS15 AAA-TS16 AAA-TS17

**Waugh Tissue Forceps**

SKU	Length	Tip
AAA-F180A	18cm	1x2 Teeth, Cross Serrated
AAA-F180B	20cm	1x2 Teeth, Cross Serrated

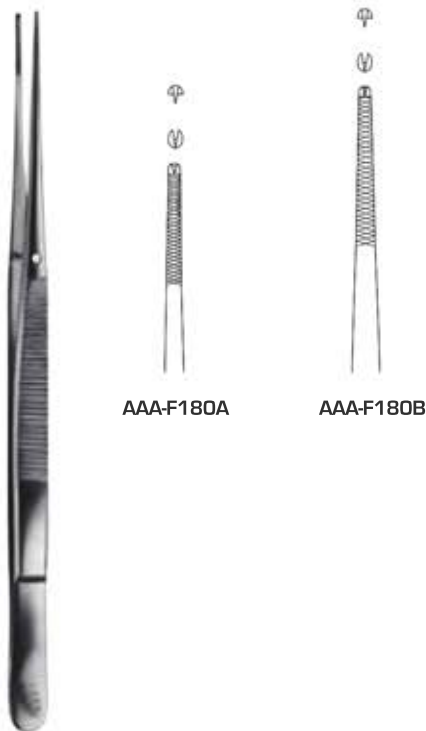

AAA-F180A AAA-F180B



**Pin Holding Forceps**

SKU	Length	Shape
PHF-150A	15cm	Angled



PHF-150A

**Forceps Pin Broke Nerve Instrument**

SKU	Length	Shape
FPB-125A	12.5cm	Angled
FPB-125S	13cm	Straight



FPB-125S



FPB-125A

# WIRE TWISTING FORCEPS

**Adams Wire Bending Forceps**

SKU	Length	Type
WTS-B508	12.5cm	Standard



WTS-B508

**Aderer Wire Bending Forceps**

SKU	Length	Type
WTS-B511	12cm	Standard



WTS-B511

**Angle Wire Bending Forceps**

SKU	Length	Type
WTS-B507	12.5cm	Standard



WTS-B507

**Jarabak Wire Bending Forceps**

SKU	Length	Type
WTS-B509	14cm	Standard



WTS-B509

Martin Wire Twisting Forceps

SKU	Length	Type	Shape
WTS-B500	15.5cm	TC	Straight
WTS-B501	15.5cm	TC	Edged
WTS-B502	15.5cm	TC	Curved
WTS-B503	18.5cm	TC	Rounded



WTS-B500



WTS-B501



WTS-B502



WTS-B503

### Schwarz Wire Bending Forceps

SKU	Length	Type
WTS-B506	13.5cm	Standard



WTS-B506

### Tweed Wire Bending Forceps

SKU	Length	Type
WTS-B510	14.5cm	Standard



WTS-B510

Wire Bending Forceps

SKU	Length	Type
WTS-B504	13.5cm	Standard
WTS-B505	12cm	TC



WTS-B504



WTS-B505

# SCISSORS



**Baby Metzenbaum Scissors**



SKU	Length	Blade	Type	Tip
S04-0145	14.5cm	Straight	Standard	B/B
S04-0147	14.5cm	Straight, Delicate	TC	B/B
S04-0146	14.5cm	Curved	Standard	B/B
S04-0148	14.5cm	Curved, Delicate	TC	B/B

**Chadwick Scissors**



SKU	Length	Blade	Type	Tip
AAA-115S	11.5cm	Curved, Delicate	Standard	S/S

**Cooper Suture Scissors**



SKU	Length	Blade	Type	Tip
COS-015	11.5cm	Curved	Standard	B/B
COS-013	13cm	Straight	Standard	B/B
COS-016	13cm	Curved	Standard	B/B
COS-014	14.5cm	Straight	Standard	B/B
COS-017	14.5cm	Curved	Standard	B/B

**Dean Gum Scissors**



SKU	Length	Blade	Type	Tip
S11-014	17cm	Angled, Serrated, Delicate	Standard	B/B

## Deaver Scissors

---

SKU	Length	Blade	Type	Tip
S11-040	14.5cm	Straight	Standard	S/B
S11-041	14.5cm	Curved	Standard	S/B



## Debakey Arteriotomy Scissors

---

SKU	Length	Blade	Type	Tip
S49-175	17.5cm	Curved	Standard	B/B



**Fomon Lower Lateral Scissors**

SKU	Length	Blade	Type	Tip
S88-135B	11.5cm	Curved	Standard	B/B
S88-135A	13.5cm	Curved	Standard	B/B



**Goldman-Fox Gum Scissors**

SKU	Length	Blade	Type	Tip
GGs-130A	13cm	Curved, 1-Serrated	Standard	S/S
GGs-130B	13cm	Curved, 1-Serrated	TC	S/S



**Iris Scissors**



SKU	Length	Blade	Type	Tip
S22-010	9cm	Straight, Delicate	Standard	S/S
S22-015	9cm	Curved, Delicate	Standard	S/S
S22-198	11cm	Straight, Delicate	Standard	S/S
S22-199	11cm	Curved, Delicate	Standard	S/S
S22-180	11cm	Straight, Delicate	TC	S/S
S22-181	11cm	Curved, Delicate	TC	S/S
S22-202	12cm	Straight, Delicate	Standard	S/S
S22-203	12cm	Curved, Delicate	Standard	S/S

**Jameson Tenotomy Scissors**



SKU	Length	Blade	Type	Tip
S91-015A	15cm	Curved	Standard	B/B

## Jameson Werber Tenotomy Scissors

SKU	Length	Blade	Type	Tip
S91-013A	13cm	Curved	Standard	B/B



## Joseph Scissors

SKU	Length	Blade	Type	Tip
S93-031	15cm	Straight	Standard	S/S
S93-032	15cm	Curved	Standard	S/S



## Kelly Scissors

---

SKU	Length	Blade	Type	Tip
S94-975A	17.5cm	Straight	Standard	S/S
S94-975B	17.5cm	Curved	Standard	S/S



## Kilner Dissecting Scissors

---

SKU	Length	Blade	Type	Tip
KDS-20A	12.5cm	Curved	Standard	Flat
KDS-20B	15cm	Curved	Standard	Flat



## La Grange Scissor

SKU	Length	Blade	Type	Tip
AAA-11LS	11cm	1-Serrated	Standard	S/S



## Lexer Dissecting Scissors

SKU	Length	Blade	Type	Tip
LXS-165A	16.5cm	Straight	Standard	B/B
LXS-165B	16.5cm	Curved	Standard	B/B





## Ligature Scissors

SKU	Length	Blade	Type	Tip
AAA-001B	14.5cm	Curved	TC	B/B
AAA-001C	18cm	Curved	TC	B/B



## Littauer Ligature Scissors

SKU	Length	Blade	Type	Tip
LAT-100A	13.5cm	Straight	Standard	B/1-Notch



**Locklin Gum Scissors**

SKU	Length	Blade	Type	Tip
LOK-155	15.5cm	Angled, Serrated	Standard	S/S



**Metzenbaum Scissors**

SKU	Length	Blade	Type	Tip
S35-990	14.5cm	Straight	Standard	B/B
S35-994	14.5cm	Straight	TC	B/B
S35-993	14.5cm	Curved	Standard	B/B
S35-997	14.5cm	Curved	TC	B/B
S35-991	18cm	Straight	Standard	B/B
S35-995	18cm	Straight	TC	B/B
S35-992	18cm	Curved	Standard	B/B
S35-996	18cm	Curved	TC	B/B



## Micro Ligature Scissors

SKU	Length	Blade	Type	Tip
MIS-121	18cm	Curved, 1-Serrated	Standard	S/S



## Nerve Dissecting Scissors

SKU	Length	Blade	Type	Tip
NDS-015	15cm	Curved	Standard	S/S



### Northbent Ligature Scissors

SKU	Length	Blade	Type	Tip
NOR-012A	12cm	Lateral-Curved	Standard	B/1-Notch



### Quinby Dissecting Scissors

SKU	Length	Blade	Type
QUB-013	13cm	Curved	Standard



## Reynolds Tenotomy Scissors

SKU	Length	Blade	Type	Tip
RTS-145B	14.5cm	Curved	Standard	B/B
RTS-175B	17.5cm	Curved	Standard	B/B



## Spencer Suture Scissors

SKU	Length	Blade	Type	Tip
SPS-201	9cm	Straight	Standard	B/1-Notch
SPS-202	11.5cm	Straight	Standard	B/1-Notch



**Spring Scissors**



SKU	Length	Blade	Type	Tip
MIS-120	18cm	Curved	Standard	S/S

**Strabismus Dissecting Scissors**



SKU	Length	Blade	Type	Tip
SEC-115A	11.5cm	Straight	Standard	B/B
SEC-115C	11.5cm	Straight, Delicate	TC	B/B
SEC-115B	11.5cm	Curved	Standard	B/B
SEC-115D	11.5cm	Curved, Delicate	TC	B/B

## Surgical Scissors



SKU	Length	Blade	Type	Tip
SSS-106	11.5cm	Straight	Standard	S/B
SSS-107	13cm	Straight	Standard	S/B
SSS-108	14.5cm	Straight	Standard	S/B
SSS-109	11.5cm	Curved	Standard	S/B
SSS-110	13cm	Curved	Standard	S/B
SSS-111	14.5cm	Curved	Standard	S/B

## Suture Scissors



SKU	Length	Blade	Type	Tip
SUT-112A	12cm	Straight	Standard	S/S
SUT-112B	12cm	Curved	Standard	S/S
SUT-113A	13cm	Straight	Standard	S/S
SUT-113B	13cm	Curved	Standard	S/S
SUT-113C	13cm	Straight	Standard	S/B
SUT-113D	13cm	Curved	Standard	S/B
SUT-145A	14.5cm	Straight	Standard	S/B
SUT-145B	14.5cm	Curved	Standard	S/B

**Toennis-Adson Dissecting Scissors**



SKU	Length	Blade	Type	Tip
TOE-175A	17.5cm	Curved	Standard	X-Del
TOE-175B	17.5cm	Curved	Standard	Del

**Gum Scissors**



SKU	Length	Blade	Type	Tip
GUM-010	12cm	Straight, Delicate	TC	S/S
GUM-011	12cm	Curved, Delicate	TC	S/S



# WIRE CUTTING SCISSORS

**Beebee Wire Cutting Scissor**



SKU	Length	Shape	Type	Style
WCS-A502	10.5cm	Straight	Standard	
WCS-A503	10.5cm	Curved	Standard	
WCS-A504	10.5cm	Straight	Standard	One Toothed Cutting Edge
WCS-A505	10.5cm	Curved	Standard	One Toothed Cutting Edge

**Martin Wire Cutting Scissor**



SKU	Length	Shape	Type	Style
WCS-A506	16cm	Straight	TC	One Toothed Cutting Edge

## Universal Wire Cutting Scissor

SKU	Length	Shape	Type	Style
WCS-A500	12cm	Angled	Standard	One Toothed Cutting Edge
WCS-A501	12.5cm	Angled	TC	One Toothed Cutting Edge



# RONGEURS

**Beyer Rongeur**

SKU	Length	Shape
BR-018A	18cm	Curved



BR-018A

**Blumenthal Bone Rongeur**

SKU	Length	Angle
BBR-014A	14cm	
BBR-145B	14.5cm	45°
BBR-015C	15cm	90°
BBR-016A	16cm	
BBR-016B	16cm	45°
BBR-016C	16cm	90°



BBR-015C



BBR-014A



BBR-145B



BBR-016C



BBR-016B



BBR-016A

**Bohler Bone Rongeur**

SKU	Length	Shape
BBR-L15A	15cm	Straight



BBR-L15A

**Cleveland Bone Rongeur**

SKU	Length	Fig
CBR-17T	14cm	1
CBR-17S	16cm	2



CBR-17T



CBR-17S

**Friedman Rongeur**

SKU	Length	Shape
S162-S14A	14cm	Straight
S162-S14B	14cm	Curved



S162-S14A



S162-S14B

**Gardner Rongeur**

SKU	Length
GR-016A	16cm



GR-016A

**Goldman-Fox Bone Rongeur**

SKU	Length
GBR-010A	10cm



GBR-010A

**Kleinert-Kutz Rongeur**

SKU	Length	Shape
KKR-014A	14cm	Curved



KKR-014A



**Leur Bone Rongeur**

SKU	Length	Shape
LBR-015A	15cm	Curved



LBR-015A

**Liston Mini Rongeur**

SKU	Length
LMR-015A	15cm



LMR-015A

**Love Kerrison Rongeur**

SKU	Length	Shape	Tip
AAA-1251	15cm	Upward	2mm
AAA-1252	15cm	Upward	4mm
AAA-1253	15cm	Upward	5mm



AAA-1251  
AAA-1252  
AAA-1253

**Mead Rongeur**

SKU	Length	Shape
MR-014A	14cm	Curved
MR-014B	17cm	Curved

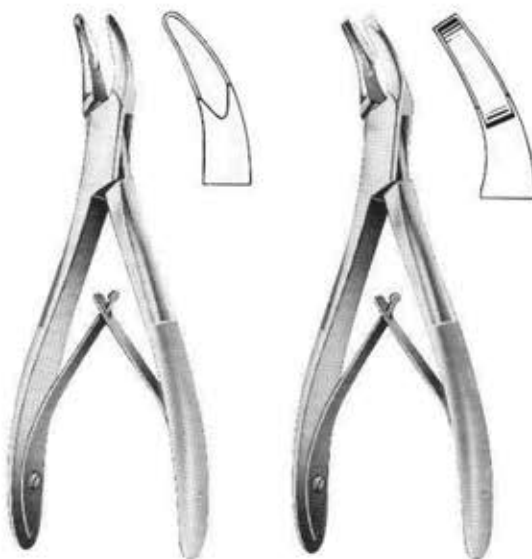

MR-014A

MR-014B

**Mini Friedman Bone Rongeur**

SKU	Length	Shape
MBR-101	12cm	Curved



MBR-101

**Niro Rongeur**

SKU	Length	Fig
NR-014A	14cm	5S



NR-014A

**Ruskin Mini Rongeur**

SKU	Length	Jaw Width
RMR-015A	15cm	2mm
RMR-015B	15cm	3mm

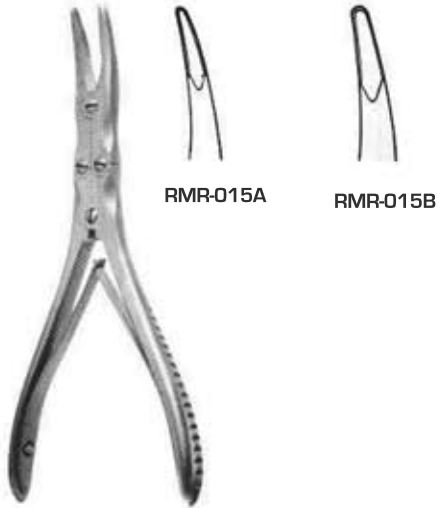

**Schell Rongeur**

SKU	Length	Shape
SR-017A	17cm	Curved



Zaufal Jansen Rongeur

SKU	Length	Shape
ZJR-018	18cm	Curved



ZJR-018

# RETRACTORS

**Bergmann Retractor**

SKU	Length	Jaw Depth
BER-1457	140mm	7mm



**Bishop Lip And Cheek Retractor**

SKU	Length	Jaw Width
BLC-135R	135mm	27mm



### Bowdler-Henry Retractor

SKU	Length	Jaw Depth	Jaw Width
BHR-170R	170mm	52mm	12mm



### Buchs Cheek Retractor

SKU	Length	Jaw Depth	Jaw Width
BLC-205B	205mm	37mm	19mm





**Cheek Retractor**

SKU	Length	Jaw Depth	Jaw Width
CHE-2154	215mm	40mm	10mm



**Denhart Mouth Retractor**

SKU	Length
DMR-110R	110mm
DMR-120R	120mm
DMR-130R	130mm



## Dockhorn Retractor

SKU	Length	Jaw Depth	Jaw Width
DHK-R200	210mm	40mm	12mm
DHK-R201	210mm	55mm	14mm



## Durham Retractor

SKU	Length	Jaw Depth	Jaw Width
DR-L22A	225mm	18mm	10mm



Farabeuf Retractor



SKU	Length	Blade
RF-L125A	125mm	25x10mm/28x12mm
RF-L125B	125mm	22x10mm/32x12mm
RF-L125C	150mm	23x16mm/24x16mm
RF-L125D	150mm	20x16mm/28x16mm

Fomon Alar Retractor



SKU	Length	Jaw Depth	Jaw Width
FR-0011R	145mm	7.4mm	12.5mm

**Frazier Retractor**

SKU	Length
FR-0012R	130mm



**Freer Skin Retractor**

SKU	Length	Jaw Depth	Jaw Width
FSK-1504	150mm	4mm	3.2mm



**Gillies Skin Retractor**



SKU	Length	Jaw Depth
GIRL100	180mm	4mm
GIRL101	180mm	5mm

**Graefe Retractor**



SKU	Length	Jaw Depth	Tip
GIRL102	125mm	1.8mm	Sharp
GIRL103	125mm	1.8mm	Blunt

Greene Retractor

SKU	Length	Jaw Depth	Jaw Width
GR-J22A	225mm	22mm	28mm



Joseph Skin Retractor

SKU	Length	Jaw Depth
JOE-1653	165mm	3mm
JOE-1656	165mm	6mm
JOE-1658	165mm	8mm



**Kilner Retractor**

SKU	Length
KIL-160X	160mm



**Kirsch Cheek Retractor**

SKU	Length	Jaw Depth	Jaw Width
RSC-210R	210mm	60mm	11mm



**Kocher-Langenbeck Retractor**



SKU	Length	Jaw Depth	Jaw Width
S117-R200	215mm	25mm	6mm
S117-R201	215mm	25mm	8mm
S117-R202	215mm	35mm	11mm
S117-R203	215mm	35mm	15mm
S117-R204	215mm	41mm	11mm
S117-R205	215mm	55mm	11mm

**Lagenbeck-Green Retractor**



SKU	Length	Jaw Depth	Jaw Width
LR-J21G	160mm	16mm	6mm
LR-J21H	160mm	24mm	6mm



**Langenbeck Retractor**



SKU	Length	Jaw Depth	Jaw Width
LR-J23A	230mm	30mm	10mm
LR-J23B	230mm	40mm	10mm
LR-J23C	230mm	43mm	13mm
LR-J21A	210mm	28mm	10mm
LR-J21B	210mm	28mm	14mm
LR-J21C	210mm	33mm	16mm
LR-J21D	210mm	40mm	10mm
LR-J21E	210mm	40mm	13mm
LR-J21F	210mm	28mm	16mm

**Laster Cheek Retractor**



SKU	Length	Jaw Width
LCR-100R	100mm	36mm

**Middeldorpf Cheek Retractor**

SKU	Length	Jaw Depth	Jaw Width
MR-J22A	220mm	15mm	15mm
MR-J22B	215mm	20mm	22mm
MR-J22C	235mm	28mm	28mm



**Minnesota (Modf.) Cheek Retractor**

SKU	Length	Jaw Depth	Jaw Width
AAA-0160	160mm	20mm	22mm



**Obwegeser Channeled Retractor**

SKU	Length	Jaw Depth
OCR-156R	165mm	8mm
OCR-157R	165mm	10mm



**Obwegeser Cheek & Soft Tissue Retractor**

SKU	Length	Jaw Depth	Jaw Width	Shape
OCS-215R	215mm	25mm	7mm	Curved Upward
OCS-216R	215mm	31mm	10mm	Curved Upward
OCS-217R	215mm	41mm	11mm	Curved Upward
OCS-218R	215mm	55mm	12mm	Curved Upward
OCS-219R	215mm	70mm	14mm	Curved Upward
OCS-220R	215mm	80mm	16mm	Curved Upward
OCS-221R	215mm	25mm	7mm	Curved Downward
OCS-222R	215mm	31mm	10mm	Curved Downward
OCS-223R	215mm	41mm	11mm	Curved Downward
OCS-224R	215mm	55mm	12mm	Curved Downward
OCS-225R	215mm	70mm	14mm	Curved Downward
OCS-226R	215mm	80mm	16mm	Curved Downward



Curved Downward



Curved Upward

**Obwegeser Chin Retractor**



SKU	Length
OCR-155R	155mm

**Ramus Retractor**



SKU	Length	Jaw Depth	Jaw Width
RAR-165A	165mm	80mm	20mm
RAR-165B	165mm	80mm	25mm
RAR-165C	165mm	80mm	30mm
RAR-220R	220mm	68mm	11mm

Ritcher Retractor

SKU	Length	Fig	Jaw Width
RIT-3180	180mm	3	15mm



Roser Koenig Mouth Gag Retractor

SKU	Length
RKM-160R	160mm
RKM-190R	190mm
RKM-185R	185mm



**Roux Cheek Retractor**

SKU	Length	Jaw Depth	Jaw Width
RR-L165A	165mm	21mm/27mm	22mm/28mm
RR-L165B	165mm	26mm/32mm	26mm/36mm
RR-L165C	165mm	30mm/36mm	30mm/44mm



**Senn-Miller (Baby) Retractor**

SKU	Length	Jaw Depth	Jaw Width
SMR-001A	155mm	8mm/22mm	7mm/7mm



**Senn-Miller Retractor**



SKU	Length	Jaw Depth	Jaw Width
SMR-001B	165mm	8mm/18mm	7mm/5.5mm

**Sternberg Cheek Retractor**



SKU	Length	Jaw Depth	Jaw Width
STC-120R	120mm	30mm/20mm	27mm/35mm
STC-130R	130mm	29mm/20mm	25mm/40mm
STC-135R	135mm	31mm/20mm	24mm/45mm

**Tessier Maxillary Retractor, Left Side**

SKU	Length	Jaw Depth	Jaw Width
TMR-150	150mm	85mm	9.2mm



**Tessier Maxillary Retractor, Right Side**

SKU	Length	Jaw Depth	Jaw Width
TMR-151	150mm	85mm	9.2mm





**University Of Minnesota Cheek Retractor**

SKU	Length
AAA-0599	130mm
AAA-0600	143mm



**Ward Cheek Retractor**

SKU	Length	Jaw Depth	Jaw Width
WCR-170R	170mm	70mm/70mm	30mm/30mm



Wassmund Retractor

SKU	Length	Jaw Depth	Jaw Width
WAR-220R	220mm	30mm	20mm



# NEEDLE HOLDERS

**Adson Needle Holder**

SKU	Length	Type
ADS-175	17.5cm	Standard



**Arruga Needle Holder**

SKU	Length	Type
ARR-016A	16cm	Standard
ARR-016B	16cm	TC



**Baumgartner Needle Holder**



SKU	Length	Type
S53-010	14cm	Standard
S53-012	14cm	TC

**Boynton Needle Holder**



SKU	Length	Type
OYN-012A	12cm	Standard
OYN-012B	12cm	TC

## Castroviejo Barraquer Needle Holder



SKU	Length	Type	Shape	Tip Profile
S43-058	13cm	Standard	Straight	Smooth
S43-059	13cm	Standard	Straight	Serrated
S43-061	13cm	Standard	Curved	Smooth
S43-060	13cm	TC	Straight	Serrated

## Castroviejo Needle Holder



SKU	Length	Type	Shape
S43-050	14cm	Standard	Straight
S43-052	14cm	Standard	Curved
S43-051	14cm	TC	Straight
S43-053	14cm	TC	Curved
S43-054	18cm	Standard	Straight
S43-056	18cm	Standard	Curved
S43-055	18cm	TC	Straight
S43-057	18cm	TC	Curved

**Crile-Wood Needle Holder**



SKU	Length	Type	Tip Profile
S52-010	15cm	Standard	Serrated
S52-001A	15cm	Standard	Smooth
S52-011	15cm	TC	Serrated
S52-012	15cm	TC	Smooth

**Derf Needle Holder**



SKU	Length	Type	Tip Profile
S60-010	12cm	Standard	Serrated

**Gillies Needle Holder**

SKU	Length	Type
S44-012	16cm	Standard
S44-013	16cm	TC



**Lichtenberg Needle Holder**

SKU	Length	Type
LIC-017A	17cm	Standard
LIC-017B	17cm	TC





**Mathieu Needle Holder**



SKU	Length	Type	Tip Profile
AAA-5014	14cm	Standard	Smooth
AAA-5015	14cm	Standard	Serrated
AAA-5016	14cm	TC	Smooth
AAA-5017	14cm	TC	Serrated
AAA-5018	17cm	Standard	Smooth
AAA-5019	17cm	Standard	Serrated

**Mayo-Hegar Needle Holder**



SKU	Length	Type
S51-012	16cm	Standard
S51-013	16cm	TC
S51-014	18cm	Standard
S51-015	18cm	TC

**Micro Barraquer Needle Holder**

SKU	Length	Type	Shape
S42-14A	14cm	Standard	Curved
S42-18A	18cm	Standard	Straight



**Mini-Ryder Needle Holder**

SKU	Length	Type
S47-011	15cm	TC
S47-012	18cm	TC



**Olson-Hegar Needle Holder**

SKU	Length	Type	Tip Profile
S46-019	14cm	Standard	Serrated



**Toennis Needle Holder**

SKU	Length	Type
TNH-018B	18cm	Standard
TNH-018A	18cm	TC



# STERILIZATION CONTAINERS & SHEET BASKETS

Dental Container

**DENTAL CONTAINER NON-PERFORATED**

Outside Dimensions	GRAY	YELLOW	RED	BLUE	GREEN	BLACK
310 X 190 X 50mm	DN01-GR	DN01-YL	DN01-RD	DN01-BL	DN01-GN	DN01-BK
310 X 190 X 65mm	DN02-GR	DN02-YL	DN02-RD	DN02-BL	DN02-GN	DN02-BK
310 X 190 X 100mm	DN03-GR	DN03-YL	DN03-RD	DN03-BL	DN03-GN	DN03-BK
310 X 190 X 130mm	DN04-GR	DN04-YL	DN04-RD	DN04-BL	DN04-GN	DN04-BK

**DENTAL CONTAINER PERFORATED**

Outside Dimensions	GRAY	YELLOW	RED	BLUE	GREEN	BLACK
310 X 190 X 50mm	DPO1-GR	DPO1-YL	DPO1-RD	DPO1-BL	DPO1-GN	DPO1-BK
310 X 190 X 65mm	DPO2-GR	DPO2-YL	DPO2-RD	DPO2-BL	DPO2-GN	DPO2-BK
310 X 190 X 100mm	DPO3-GR	DPO3-YL	DPO3-RD	DPO3-BL	DPO3-GN	DPO3-BK
310 X 190 X 130mm	DPO4-GR	DPO4-YL	DPO4-RD	DPO4-BL	DPO4-GN	DPO4-BK



Bottom Non-Perforated    Bottom Perforated



**Mini Sterilization Perforated Sheet Basket**

SKU	Dimensions
SSB-01	265 x 125 x 30mm
SSB-02	265 x 125 x 50mm
SSB-03	265 x 125 x 70mm



**Mini Sterilization Perforated Sheet Basket with Lid**

SKU	Dimensions
SSBL-01	265 x 125 x 30mm
SSBL-02	265 x 125 x 50mm
SSBL-03	265 x 125 x 70mm



**Half Size Sterilization Perforated Sheet Basket**

SKU	Dimensions
HSSB-01	244 x 255 x 30mm
HSSB-02	244 x 255 x 50mm
HSSB-03	244 x 255 x 70mm
HSSB-04	244 x 255 x 100mm



**Half Size Sterilization Perforated Sheet Basket with Lid**

SKU	Dimensions
HSBL-01	244 x 255 x 30mm
HSBL-02	244 x 255 x 50mm
HSBL-03	244 x 255 x 70mm
HSBL-04	244 x 255 x 100mm



**Middle Size Sterilization Perforated Sheet Basket**



SKU	Dimensions
MSHB-01	405 x 255 x 30mm
MSHB-02	405 x 255 x 50mm
MSHB-03	405 x 255 x 70mm
MSHB-04	405 x 255 x 100mm

**Middle Size Sterilization Perforated Sheet Basket with Lid**



SKU	Dimensions
MSHBL-01	405 x 255 x 30mm
MSHBL-02	405 x 255 x 50mm
MSHBL-03	405 x 255 x 70mm
MSHBL-04	405 x 255 x 100mm



**Special Size Sterilization Perforated Sheet Basket**

SKU	Dimensions
SHBT-01	485 x 255 x 30mm
SHBT-02	485 x 255 x 50mm
SHBT-03	485 x 255 x 70mm
SHBT-04	485 x 255 x 100mm



**Special Size Sterilization Perforated Sheet Basket with Lid**

SKU	Dimensions
SHBL-01	485 x 255 x 30mm
SHBL-02	485 x 255 x 50mm
SHBL-03	485 x 255 x 70mm
SHBL-04	485 x 255 x 100mm



**Full Size Sterilization Perforated Sheet Basket**

SKU	Dimensions
FSHB-01	540 x 255 x 30mm
FSHB-02	540 x 255 x 50mm
FSHB-03	540 x 255 x 70mm
FSHB-04	540 x 255 x 100mm



**Full Size Sterilization Perforated Sheet Basket with Lid**

SKU	Dimensions
FSHBL-01	540 x 255 x 30mm
FSHBL-02	540 x 255 x 50mm
FSHBL-03	540 x 255 x 70mm
FSHBL-04	540 x 255 x 100mm



## Bone Files

Buck Periodontal File	141
Hirschfeld Peiodontal File	142
Miller-Colburn Bone File	142
Schluger Periodontal File	141
Sugarmen Periodontal File	140
Wahl Bone File	140

## Burnishers

Ball Burnisher	184
Beavertail Burnisher	184
Dental Burnisher	185
Ladmore Burnisher	185
White Burnisher	186

## Carvers

Andrew Carver	132
Clappison Carver	132
Cleoid Discoid Carver	133
Cleoid Discoid Carver Vignon	133
Frahm Carver	134
Hollenback Carver	134
Hollenback Cleoid	135
Interproximal Carver	135
Lecron Carver	136
Sprengel Carver	136
Tanner Carver	137
Tharp Carver	137
Vehe Carver	138
Ward Carver	138
Wiland Carver	138

## Cement Spatulas

Cement Spatula	223
----------------	-----

## Chisels & Osteotomes

Buckley Bone Chisel	157
Chandler Bone Chisel	157
Fedi Periodontal Chisel	158
Freer Chisel	158
Gardner Bone Chisel	159
Jovanovic Periodontal Chisel	159
Kirkland Periodontal Chisel	160
Lucas Chisel	160
Ochsenbein Periodontal Chisel	161
Partsch Bone Chisel	161
Rhodes Dental Chisel	162
Ridge Split Chisel	162
Sinus Lift Osteotome (with Marking 6mm, 8mm, 11mm, 15mm)	163

Solt Periodontal Chisel	164
Wakefield Bone Chisel	164
Wedelstaedt Enamel Chisel	165
White Enamel Chisel	165

## Crown Removers

Automatic Crown Remover With Two Points	237
Beebee Crown Scissors	237
Crown Spreader	238
Furrer Crown Ring Removing Plier	238
Mershon Crown Depressor	239
Miller Crown Remover	239
Monfort Crown Slitter	240
Morrell Crown Remover With Three Points	240
Planert Crown Dilating Forceps	241
Schroeder Crown Remover	241
Treymann Crown Remover	242

## Curettes

Chompret Bone Curette	87
Columbia Curette	87
Crane Kaplan Curette	88
Goldman-Fox Curette	88
Gracey Mesial Distal Curette	89
Gracey Curette	89, 90
Hemingway Bone Curette	91
Hoexter Periodontal Curette	92
Jacquette Curette	92
Kirkland Periodontal Curette	93
Kramer Nevins Periodontal Curette	93
Langer Curette	94
Lucas Dental Curette	94
Martini Bone Curette	95
Mead Bone Curette	95
Miller Colburn Bone Curette	96
Molt Dental Curette	96
McCall Curette	97
Prichard Periodontal Curette	97
Sugarmen Periodontal Curette	98
Towner / Jacquette	98
Towner Curette	101
USA Bone Curette	99
Williger Bone Curette	100
Younger-Good Curette	101

## Dental Syringes

Breech Loading Syringe	268
Cylinder Cartridge Syringe	268
Dental Aspirating Syringe	269
Metal Water Syringe With 1 Cannula (Luer Lock)	269

Water Syringe With 1 Cannula (Luer Lock)	269
---	-----

## Endodontic Spreaders

Endodontic Spreader	167, 168
Steiner Endodontic Spreader	168

## Excavators

Ash Excavator	153
Darby Perry Excavator	153
Dental Excavator	154, 155
White Excavator	155

## Explorers & Probes

Briault Explorer	170
Dental Explorer	170, 171, 172
Glickman Measuring Probe	173
Goldman-Fox Explorer / Measuring Probe	173
Holst A Explorer	174
Holst Explorer	174
Hospital Explorer	174
Lange Explorer	175
Measuring Probe Single Ended	175
Merritt Measuring Probe	176
Michigan Periodontal Probe	176
Nabers Periodontal Pocket Probe	176
Old Dominion University Explorer	177
Orban Explorer	177
Periodontal Pocket Probe	177
Periodontal Probe	178
Periodontal Probe / Explorer	178
Scheff Explorer	178
Shepherd Explorer	179
Thin Williams Explorer / Measuring Probe	179
University Of North Carolina Measuring Probe Single Ended	179
Weston Explorer	181
White Explorer	180
Wilkins / Tufts Explorer	181
William-Fox Measuring Probe And Explorer	182
Williams Periodontal Probe	182

## Extracting Forceps

American Pattern Tooth Extracting Forceps	7, 8, 9, 10, 11, 12
American Pattern Tooth Extracting Forceps - Child	13
American Pattern Tooth Extracting Forceps - Cowhorn	14

American Pattern Tooth Extracting Forceps - Physick	14
American Pattern Tooth Extracting Forceps - Tomes	13
Busch Extracting Forceps	15
Cryer American Pattern Tooth Extracting Forceps	15
English Pattern Tooth Extracting Forceps	16, 17, 18, 19, 20, 21, 22, 23, 24, 25, 26, 27, 28, 29, 30, 31, 32
English Pattern Tooth Extracting Forceps - Child	33, 34, 35, 36
English Pattern Tooth Extracting Forceps - Cowhorn	37
English Pattern Tooth Extracting Forceps - Guys	37
Extracting Forceps With Anatomically Shaped Handle	38, 39, 40
Henahan American Pattern Tooth Extracting Forceps	41
Hull American Pattern Tooth Extracting Forceps	41
Kells American Pattern Tooth Extracting Forceps	41
Klein Pattern Tooth Extracting Forceps	42, 43
Lawrence Read Forceps - Child	43
Mead Pattern Extracting Forceps	44
Milwaukee American Pattern Tooth Extracting Forceps	46
Nevius American Pattern Tooth Extracting Forceps	45
Parmly Alveolar American Pattern Tooth Extracting Forceps	46
Relax Extracting Forceps	47
Root Splinter Extracting Forceps	48
Routurier Extracting Forceps	48
Stiksa Extracting Forceps	49
Thomas American Pattern Tooth Extracting Forceps	50
Witzel Root Fragment Forceps	50
Woodward American Pattern Tooth Extracting Forceps	51

## Filling Instruments

Ash Filling Instruments	76
Bennett Filling Instruments	77
Dycal Filling Instrument	77
Ewards Filling Instrument	78
Heidemann Filling Instruments	78
Ladmore Filling Instrument	79
Linsemann Filling Instrument	79
Plastic Filling Instrument - Series 1	80
Plastic Filling Instrument - Series 2	81
Plastic Filling Instrument - Series 3, Axial	82

Thymozine Filling Instrument	83
Ward Filling Instrument	85
White Filling Instruments	84
Williams Filling Instruments	84
Woodson Plastic Filling Instrument	83

## Finishing Files

Black Finishing File	150
Rhein Finishing File	150
Tompkins Finishing File	151
Wedelstaedt Finishing File	151

## Impression Trays

Impression Tray Upper Non-Perforated	251
Impression Tray Lower Non-Perforated	252
Impression Tray Upper Perforated	253
Impression Tray Lower Perforated	254
Impression Tray Form C1/2	254
Impression Tray Form C1/3	255
Impression Tray Form C1/4	255
Impression Tray Form C1/5	255
Impression Tray Form C1/6	256
Impression Tray Form C1/7	256
Impression Tray Form C1/8	256
Impression Tray Form C1/9	257
Impression Tray Universal	257
Impression Tray Stolley	257

## Mallets

Cottle Mallet	271
Hajek Mallet	271
Herbert Mallet	272
Mallet	272
Mead Mallet	273
Williger Mallet	273

## Matrix Retainers & Matrix Bands

Didner Matix Retainer	225
Ivory Matrix Retainer	225, 226
Matrix Band For Molars	226
Matrix Band For Premolars	227
Nystroem Matrix Retainer	227
Tofflemire Matrix Band	228
Tofflemire Matrix Retainer	228

## Mouth Mirrors

Mouth Mirror (Magnifying)	218
Mouth Mirror (Plane)	218
Mouth Mirror (Rhodium)	219

Parallelometer Mouth Mirror	219
Parallelometer Mouth Mirror Handle	219
Parallelometer Mouth Mirror With Handle	220
Mouth Mirror Handle	220
Martin-Grip Mouth Mirror Handle	221
Martin Ergo Mouth Mirror Handle	221

## Needle Holders

Adson Needle Holder	349
Arruga Needle Holder	349
Baumgartner Needle Holder	350
Boynton Needle Holder	350
Castroviejo Barraquer Needle Holder	351
Castroviejo Needle Holder	351
Crile-Wood Needle Holder	352
Derf Needle Holder	352
Gillies Needle Holder	353
Lichtenberg Needle Holder	353
Mathieu Needle Holder	354
Mayo-Hegar Needle Holder	354
Micro Barraquer Needle Holder	355
Mini-Ryder Needle Holder	355
Olson Hegar Needle Holder	356
Toennis Needle Holder	356

## Orthodontic Pliers

Abell Contouring Plier	188
Adam Orthodontics Dental Plier	188
Adams Wire Bending Plier	188
Aderer Clasp Bending Plier	189
Aderer Wire Bending Plier	189
Ainsworth Punch Plier	189
Andresen Wire Bending Plier	190
Angle Arch Bending Plier	190
Angle Wire Bending Plier	190
Ball Hook Crimping Plier Angled	191
Bird Beak Orthodontic Plier	191
Boehm Telescopic Crown Plier	191
Bracket Removing Plier	192
Distal End Cutter Plier	192
Dumont Flat Nose Plier	192
Dumont Round Nose Plier	193
Fischer Wire Bending Plier	193
Flat Nose Plier	193
Frevert Contouring Plier	194
Furrer Copper Ring Removing Plier	194
Gordon Contouring Plier	194
Goslee Flat Contour Plier	195
How Crown Plier	195
Jarabak Light Wire Plier	195
Johnson Contouring Plier	196

Korkhaus Ligature Plier	196
Langbeck Flat Nose Plier	196
McKellops Sling Forming Plier	197
McKellops Wire Bending Plier	197
Module Strokes Separating Plier	197
Nance Orthodontic Plier	198
Nerve Canal Plier	198
O'Brien Orthodontic Plier	198
Oliver Band Removing Plier	199
Oliver Jones Band Removing Plier	199
Palmer Rubber Dam Clamp Plier	199
Peeso Contouring Plier	200
Reynolds Contouring Plier	200
Round Nose Plier	200
Schwarz Bending Plier	201
Schwarz I Bar Bending Plier	201
Schwarz II Bar Bending Plier	202
Schwarz III Bar Bending Plier	202
Slim Weingart Plier	201
Triplex Contouring Plier	202
Tryfus Crown Forming Plier	203
Tweed Orthodontic Plier	203
Universal Flat Nose Plier	203
Universal Pin Bending Plier	204
Waldsachs Universal Plier	204
Weingart Ligature Plier	204
Young Wire Bending Plier	205

## Periodontal Knives

Buck Periodontal Knife	103
Crane-Kaplan Periodontal Knife	103
Goldman-Fox Periodontal Knife	104
Kirkland Periodontal Knife	104
Kramer-Nevin Periodontal Knife	105
Orban Periodontal Knife	105, 106
Reddy Thin Periodontal Knife	106

## Periosteal Dental Elevators

Aljberg Periosteal Dental Elevator	259
Allen Iglhaut Periosteal Dental Elevator	259
Alley Periosteal Dental Elevator	260
Bennet Periosteal Dental Elevator	260
Emons Periosteal Dental Elevator	261
Freer Periosteal Dental Elevator	261
Henahan Periosteal Dental Elevator	262
Iglhaut Periosteal Dental Elevator	262
Kahre-Williger Periosteal Dental Elevator	263
Korner/Westermann Periosteal Dental Elevator	263
Molt Periosteal Dental Elevator	264
Ohl Periosteal Dental Elevator	264

Prichard Periosteal Dental Elevator	265
Seldin Periosteal Dental Elevator	265
West Bone Periosteal Dental Elevator	266
Williger Periosteal Dental Elevator	266

## Plaster & Alginate Spatulas

Flexible Spatula	230
Rigid Spatula	230

## Pluggers

Amalgam Plugger	144
Haubeil Amalgam Plugger	144
Hollenback Amalgam Plugger	145
Luks Plugger	145
Machtou Root Canal Plugger	146
Root Canal Plugger	146
Schilder Plugger	147
Thuerniegel Root Canal Plugger	147
Vertical Condenser	148

## Retractors

Bergmann Retractor	328
Bishop Lip And Cheek Retractor	328
Bowdler-Henry Retractor	329
Buchs Cheeks Retractor	329
Cheek Retractor	330
Denhart Mouth Retractor	330
Dockhorn Retractor	331
Durham Retractor	331
Farabeuf Retractor	332
Fomon Alar Retractor	332
Frazier Retractor	333
Freer Skin Retractor	333
Gillies Skin Retractor	334
Graefe Retractor	334
Greene Retractor	335
Joseph Skin Retractor	335
Kilner Retractor	336
Kirsch Cheek Retractor	336
Kocher-Langenbeck Retractor	337
Lagenbeck-Green Retractor	337
Langenbeck Retractor	338
Laster Cheek Retractor	338
Middeldorpf Cheek Retractor	339
Minnesota (Modf.) Cheek Retractor	339
Obwegeser Channeled Retractor	340
Obwegeser Cheek & Soft Tissue Retractor	340
Obwegeser Chin Retractor	341
Ramus Retractor	341
Ritcher Retractor	342

Roser Koenig Mouth Gag Retractor	342
Roux Cheek Retractor	343
Senn-Miller (Baby) Retractor	344
Senn-Miller Retractor	344
Sternberg Cheek Retractor	345
Tessier Maxillary Retractor, Left Side	345
Tessier Maxillary Retractor, Right Side	346
University Of Minnesota Cheek Retractor	346
Ward Cheek Retractor	347
Wassmund Retractor	

## Rongeurs

Beyer Rongeur	318
Blumenthal Bone Rongeur	318
Bohler Bone Rongeur	319
Cleveland Bone Rongeur	319
Friedman Rongeur	320
Gardner Rongeur	320
Goldman-Fox Bone Rongeur	321
Kleinert-Kutz Rongeur	321
Leur Bone Rongeur	322
Liston Mini Rongeur	322
Love Kerrison Rongeur	323
Mead Rongeur	323
Mini Friedman Bone Rongeur	324
Niro Rongeur	324
Ruskin Mini Rongeur	325
Schell Rongeur	325
Zaufal Jansen Rongeur	326

## Root Elevator

Apexo Root Elevator	53
Apical Root Elevator	53
Barry Root Elevator	54
Bein Root Elevator	55
Bein Root Elevator - Bayonet Mesial	56
Chompret Root Elevator	56
Coupland Elevator	57
Crane Pick Root Elevator	57
Cryer Root Elevator	58, 59
Cryer Root Elevator Handle	59
Curtis Root Elevator	60
Flohr Root Elevator	60
Friedman Root Elevator	61
Heidbrink Root Elevator	61, 62
Heidbrink Root Tip Pick Elevator	62
Hourigan Root Elevator - Serrated	63
Hyllin Root Elevator	63
Kopp Root Elevator	64



<i>Kopp Root Elevator - Bayonet</i>	65
<i>Kopp Root Elevator Handle</i>	65
<i>Krallenheber Root Elevator</i>	66
<i>Lecluse Root Elevator</i>	66
<i>London Hospital Elevator</i>	67
<i>Loos Root Elevator</i>	67
<i>Luxator Root Elevator</i>	68
<i>MacMillan Gouge Root Elevator</i>	68
<i>Mead Root Elevator</i>	69
<i>Miller Root Elevator</i>	69
<i>Pott Root Elevator</i>	70
<i>Ratzow Root Elevator</i>	70
<i>Seldin Root Elevator</i>	71
<i>Stout Root Elevator</i>	71
<i>Vignal Root Elevator</i>	72
<i>Vignal Root Elevator - Bayonet</i>	72
<i>Warwick-James Elevator</i>	73
<i>Winter Root Elevator</i>	74
<i>Woodward Root Elevator</i>	73

## Rubber Dam Clamps & Forceps

<i>Ainsworth Rubber Dam Forceps</i>	232
<i>Brewer Rubber Dam Forceps</i>	233
<i>Ivory Rubber Dam Clamp</i>	232
<i>Ivory Rubber Dam Forceps</i>	233
<i>Ivory Rubber Dam Forceps, Flat</i>	233
<i>Palmer Rubber Dam Forceps</i>	234
<i>Rubber Dam Frame</i>	235
<i>Stokes Rubber Dam Forceps</i>	234

## Scalers

<i>Abott Scaler</i>	108
<i>Baylor Scaler</i>	108
<i>Black Scaler</i>	109
<i>California Scaler</i>	110
<i>Cleveland Scaler</i>	110
<i>Columbia Scaler</i>	111
<i>Crane Kaplan Scaler</i>	111
<i>Cumine Scaler</i>	112
<i>Cushing Scaler</i>	112
<i>Darby-Perry Scaler</i>	112
<i>Fehr Scaler</i>	113
<i>Globe Scaler</i>	113
<i>Goldman-Fox Scaler</i>	113
<i>Guenther Scaler</i>	114
<i>Guy Scaler</i>	114
<i>Haubeil Scaler</i>	115
<i>Hygienist Scaler</i>	115
<i>Jacquette Scaler</i>	116
<i>Langer Scaler</i>	117
<i>McCall Scaler</i>	118

<i>Mitchell Scaler</i>	117
<i>Moore Scaler</i>	119
<i>Muehleman Scaler</i>	119
<i>Remington Scaler</i>	120
<i>Scaler Double Ended</i>	120
<i>Scaler Single Ended</i>	121
<i>Scaler Single Ended Series 1</i>	122
<i>Scaler Single Ended Series 2</i>	122
<i>Scaler USC</i>	123
<i>Scharmman Scaler</i>	123
<i>Senns Scaler</i>	124
<i>Shepherd Scaler</i>	124
<i>Sichel 23 Scaler</i>	125
<i>Smith Scaler</i>	125
<i>Taylor Scaler</i>	126
<i>Thorpe I Scaler</i>	126
<i>Thorpe II Scaler</i>	126
<i>Tompkins Scaler</i>	127
<i>Towner Jacqueline Scaler</i>	127
<i>White Scaler</i>	128
<i>Whiteside Scaler</i>	128
<i>Whitten Scaler</i>	129
<i>Williger Scaler</i>	129
<i>Younger 15</i>	130
<i>Younger Good Scaler</i>	130
<i>Zerfing Scaler</i>	130

## Scissors

<i>Baby Metzenbaum Scissors</i>	298
<i>Chadwick Scissors</i>	298
<i>Cooper Suture Scissors</i>	299
<i>Dean Gum Scissors</i>	299
<i>Deaver Scissors</i>	300
<i>Debakey Arteriotomy Scissors</i>	300
<i>Fomon Lower Lateral Scissors</i>	301
<i>Goldman-Fox Gum Scissors</i>	301
<i>Gum Scissors</i>	313
<i>Iris Scissors</i>	302
<i>Jameson Tenotomy Scissors</i>	302
<i>Jameson Werber Tenotomy Scissors</i>	303
<i>Joseph Scissors</i>	303
<i>Kelly Scissors</i>	304
<i>Kilner Dissecting Scissors</i>	304
<i>La Grange Scissor</i>	305
<i>Lexer Dissecting Scissors</i>	305
<i>Ligature Scissors</i>	306
<i>Littauer Ligature Scissors</i>	306
<i>Locklin Gum Scissors</i>	307
<i>Metzenbaum Scissors</i>	307
<i>Micro Ligature Scissors</i>	308
<i>Nerve Dissecting Scissors</i>	308
<i>Northbent Ligature Scissors</i>	309

<i>Quinby Dissecting Scissors</i>	309
<i>Reynolds Tenotomy Scissors</i>	310
<i>Spencer Suture Scissors</i>	310
<i>Spring Scissors</i>	311
<i>Strabismus Dissecting Scissors</i>	311
<i>Surgical Scissors</i>	312
<i>Suture Scissors</i>	312
<i>Toennis-Adson Dissecting Scissors</i>	313

## Sterilization Containers & Sheet Baskets

<i>Dental Container Bottom Perforated</i>	358
<i>Dental Container Non-Perforated</i>	358
<i>Full Size Sterilization Perforated Sheet Basket</i>	363
<i>Full Size Sterilization Perforated Sheet Basket with Lid</i>	363
<i>Half Size Sterilization Perforated Sheet Basket</i>	360
<i>Half Size Sterilization Perforated Sheet Basket with Lid</i>	360
<i>Middle Size Sterilization Perforated Sheet Basket</i>	361
<i>Middle Size Sterilization Perforated Sheet Basket with Lid</i>	361
<i>Mini Sterilization Perforated Sheet Basket</i>	359
<i>Mini Sterilization Perforated Sheet Basket with Lid</i>	359
<i>Special Size Sterilization Perforated Sheet Basket</i>	362
<i>Special Size Sterilization Perforated Sheet Basket with Lid</i>	362

## Tongue Depressors

<i>Davis-Boyle Tongue Depressor</i>	207
<i>Dingmann Tongue Depressor</i>	207
<i>Hartmann Tongue Depressor</i>	208
<i>Mclvor Tongue Depressor</i>	208
<i>Negus Tongue Depressor</i>	209
<i>Russel-Davis Tongue Depressor</i>	210
<i>Tobold Tongue Depressor</i>	209

## Towel Clamps

<i>Backhaus Towel Clamp</i>	212
<i>Bernhard Towel Clamp</i>	212
<i>Doyen Towel Clamp</i>	212
<i>Jones Towel Clamp</i>	213
<i>Peers-Bertram (Modified) Towel Clamp</i>	213
<i>Peers-Bertram Towel Clamp</i>	214
<i>Robin Towel Clamp</i>	214
<i>Roeder Towel Clamp</i>	215
<i>Schaedel Towel Clamp</i>	215
<i>Tohoko Towel Clamp</i>	216

## Tweezers & Forceps

---

<i>Adson Brown Forceps</i>	275
<i>Adson Forceps</i>	275
<i>Albrecht Tweezer</i>	276
<i>Allen Tooth Tweezer</i>	276
<i>Brophy Forceps</i>	277
<i>Ck1 Dental Tweezer</i>	277
<i>Ck2 Dental Tweezer</i>	277
<i>Cushing Forceps</i>	278
<i>Debakey Atraumatic Forceps</i>	278
<i>Dissecting Forceps</i>	279
<i>Dressing Forceps</i>	279, 280
<i>Flag Dental Tweezer</i>	280
<i>Forceps Pin Broke Nerve Instrument</i>	290
<i>Gerald Tissue Forceps</i>	281
<i>Gf1 Dental Tweezer</i>	281
<i>Gf2 Dental Tweezer</i>	281
<i>Gillies Tissue Forceps</i>	282
<i>Gross Dressing Forceps</i>	282
<i>Kopp Dental Tweezer</i>	283
<i>Landgraf Dental Tweezer</i>	283
<i>Lister Sponge And Dressing Forceps</i>	284
<i>London College Tooth Tweezer</i>	284
<i>McIndoe Dissecting Forceps</i>	284
<i>Meriam Dental Tweezer</i>	285
<i>Micro Dressing And Suture Forceps</i>	285
<i>Micro-Adson Forceps</i>	286
<i>Perry Dental Tweezer</i>	286
<i>Pin Holding Forceps</i>	290
<i>Potts Smith Dressing Forceps</i>	287
<i>Semken Tissue Forceps</i>	287
<i>Standard Forceps</i>	288
<i>Suture Forceps</i>	288
<i>Tissue Forceps</i>	289
<i>Waugh Tissue Forceps</i>	289

## Wire Cutting Scissors

---

<i>Beebee Wire Cutting Scissors</i>	315
<i>Martin Wire Cutting Scissors</i>	315
<i>Universal Wire Cutting Scissors</i>	316

## Wire Twisting Forceps

---

<i>Adams Wire Bending Forceps</i>	292
<i>Aderer Wire Bending Forceps</i>	292
<i>Angle Wire Bending Forceps</i>	293
<i>Jarabak Wire Bending Forceps</i>	293
<i>Martin Wire Twisting Forceps</i>	294
<i>Schwarz Wire Bending Forceps</i>	295
<i>Tweed Wire Bending Forceps</i>	295
<i>Wire Bending Forceps</i>	296

## Wax, Porcelain & Modeling Instruments

---

<i>Antkoviak Wax Knife</i>	244
<i>Beale Wax Spatula</i>	244
<i>Con Scodellino Wax Knife</i>	245
<i>Ermert Wax Spatula</i>	245
<i>Fahnstock Wax Knife</i>	246
<i>Frahm Modelling Instrument</i>	246
<i>Gisy Wild Wax Knife</i>	247
<i>Gritman Plaster Knife</i>	247
<i>Lessmann Wax Knife</i>	248
<i>Medicon Modelling Instrument</i>	248
<i>Plaster Knife</i>	249

# Quality Instruments Enhanced Practices Better Lives!

**Alira**  
MEDICAL DEVICES

**Tell:** (818) 614 4592

**Email:** [info@alirameddevices.com](mailto:info@alirameddevices.com)

**Web** [www.alirameddevices.com](http://www.alirameddevices.com)



**Address:** 14622 Ventura Blvd Ste 102,  
#712 Sherman Oaks, CA 91403